

8 Digit Up/Down/Up • Down Counter

DIN W72 × H72, W144 × H72mm of 8 Digit Up/Down counter

■ Features

- 8 Digits counter
- Selectable Up, Down, Up/Down mode
- Counting speed : 1cps, 30cps, 2kcps, 5kcps
- Selectable voltage input (PNP) or no-voltage input (NPN)
- Decimal point setting (Fixed decimal point of display)
- Wide range of input power supply :
100–240VAC 50/60Hz, 12–24VAC/DC
- Built-in Microprocessor



⚠ Please read "Caution for your safety" in operation manual before using.

■ Specifications

Model	Single preset		F8A	L8A
	Indication type		F8B	L8B
Digit			8 (99999999)	8 (99999999)
Digit size			W4 × H8mm	W6.3 × H10mm
Power supply			100–240VAC 50/60Hz, 12–24VAC/DC	
Allowable voltage range			90 ~ 110% of rated voltage	
Power consumption			<ul style="list-style-type: none"> • Preset : Approx. 6.1VA (240VAC 60Hz), Approx. 3.1W (24VDC), Approx. 6.3VA (24VAC 60Hz) • Indication type : Approx. 5.4VA (240VAC 60Hz), Approx. 2.6W (24VDC), Approx. 5.5VA (24VAC 60Hz) 	
Max. counting speed			Selectable 1cps/30cps/2kcps/5kcps by internal DIP switch	
Min. signal width	RESET input	Approx. 20ms		
Input type	CP1, CP2 Input	[Voltage input] Input impedance : 5.4kΩ, "H" level voltage : 5–30VDC, "L" level voltage : 0–2VDC		
	RESET input	[No-Voltage input] Impedance at short-circuit : Max. 1kΩ, Residual voltage at short-circuit : Max. 2VDC, Impedance at open-circuit : Max. 100kΩ		
Control output	Con-tact	Type	Single preset : SPDT (1c)	
		Capacity	250VAC 3A resistive load	
	Solid-state	Type	Single preset Type : 1 NPN open collector	
		Capacity	30VDC Max. 100mA Max.	
Memory protection	10 years (When using non-volatile semiconductor memory)			
External power	12VDC ± 10% 50mA Max.			
Ambient temperature	–10 ~ +55°C (at non-freezing status)			
Storage temperature	–25 ~ +65°C (at non-freezing status)			
Ambient humidity	35 ~ 85%RH			
Insulation resistance	100MΩ (at 500VDC)			
Dielectric strength	2000VAC 50/60Hz for 1 minute			
Noise strength	AC power	±2kV the square wave noise (pulse width: 1μs) by the noise simulator		
	DC power	±500V the square wave noise (pulse width: 1μs) by the noise simulator		
Vibration	Mechanical	0.75mm amplitude at frequency of 10 ~ 55Hz in each of X, Y, Z directions for 1 hour		
	Malfunction	0.5mm amplitude at frequency of 10 ~ 55Hz in each of X, Y, Z directions for 10 minutes		
Shock	Mechanical	300m/s ² (Approx. 30G) in X, Y, Z directions 3 times		
	Malfunction	100m/s ² (Approx. 10G) in X, Y, Z directions 3 times		
Relay life cycle	Mechanical	Min. 10,000,000 times		
	Electrical	Min. 100,000 times (250VAC 3A at resistive load)		
Unit weight	AC power	F8A : Approx. 287g, F8B : Approx. 253g	L8A : Approx. 500g, L8B : Approx. 446g	
	DC power	F8A : Approx. 283g, F8B : Approx. 253g	L8A : Approx. 498g, L8B : Approx. 444g	

(A) Counter

(B) Timer

(C) Temp. controller

(D) Power controller

(E) Panel meter

(F) Tacho/Speed/Pulse meter

(G) Display unit

(H) Sensor controller

(I) Switching power supply

(J) Proximity sensor

(K) Photo electric sensor

(L) Pressure sensor

(M) Rotary encoder

(N) Stepping motor & Driver & Controller

(O) Graphic panel

(P) Production stoppage models & replacement

F/L Series

Dimensions

F Series

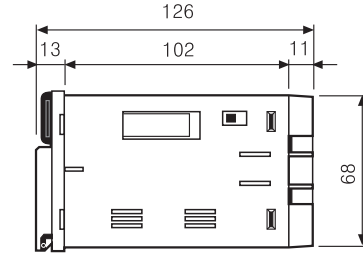
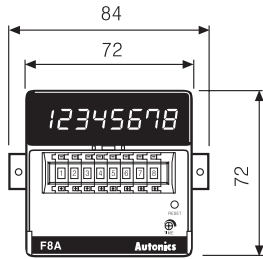

Panel cut-out

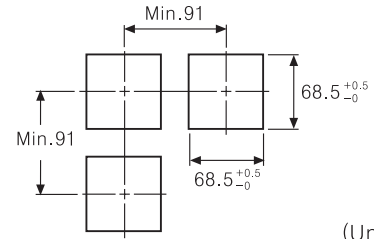

(Unit:mm)

L Series

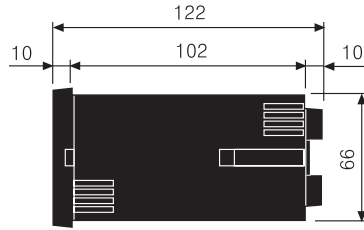
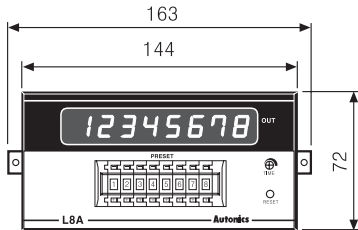

Panel cut-out

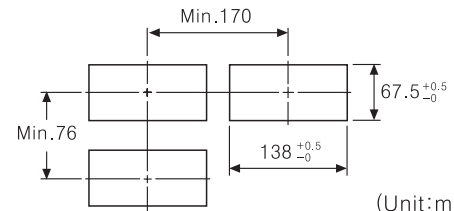

(Unit:mm)

Connections

F8A

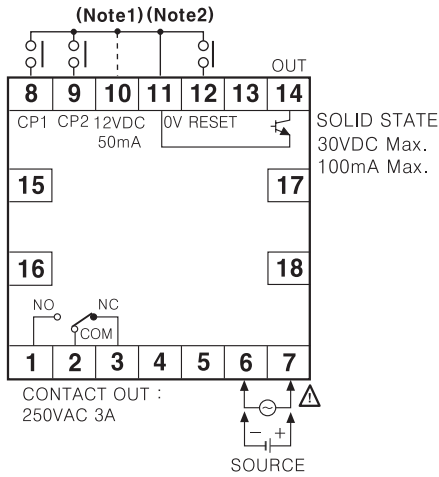

F8B

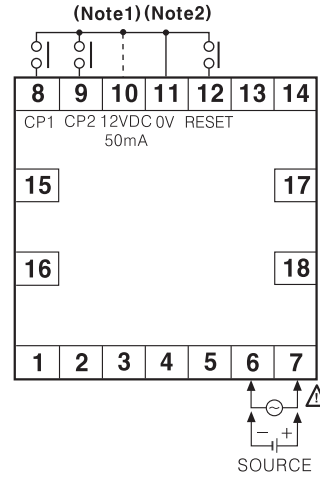

L8A

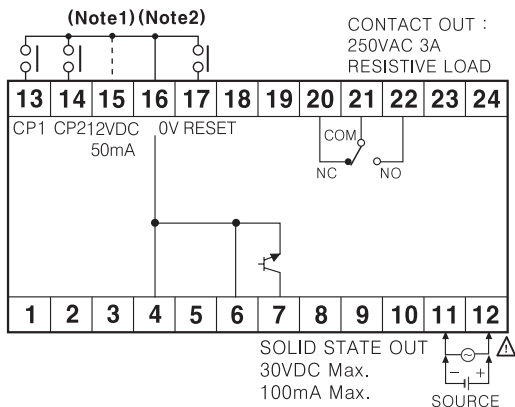

L8B

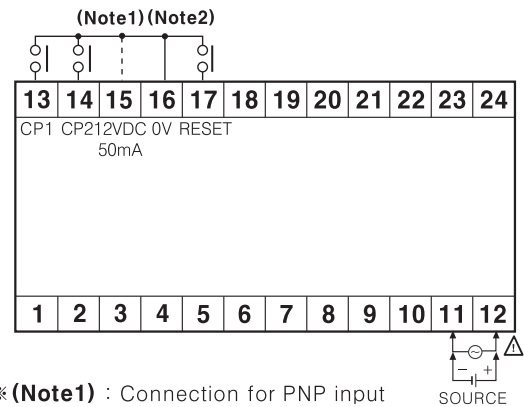

※ (Note1) : Connection for PNP input
 (Note2) : Connection for NPN input

8 Digit Up/Down/Up • Down Counter

Input logic selection

●F Series

Input logic is changeable by input logic selection switch located at the one-side of case.

- No voltage input(NPN)
- Voltage input(PNP)

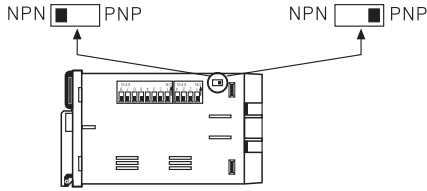

●L Series

Input logic is changeable by input logic selection switch located at the terminal block.

- No voltage input(NPN)
- Voltage input(PNP)

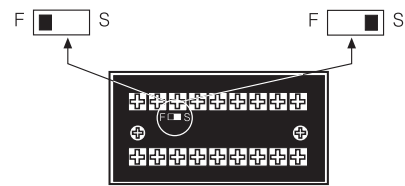

※ Please be sure to turn OFF the power before changing input logic.

Input connections

○No voltage input(NPN)

- Solid-state input(Standard input sensor : NPN output type sensor)

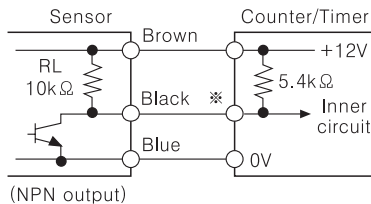

(NPN output)

※CP1, CP2, RESET input

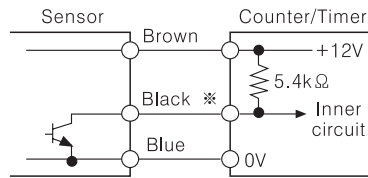

(NPN open collector output)

- Contact input

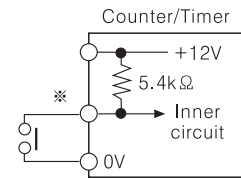

Counting speed :
Set as 1 or 30cps

○Voltage input(PNP)

- Solid-state input(Standard input sensor : PNP output type sensor)

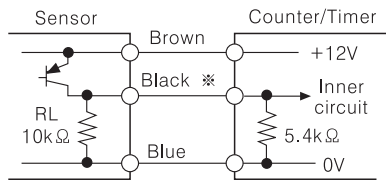

(PNP output)

※CP1, CP2(INHIBIT), RESET input

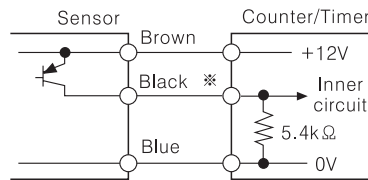

(PNP open collector output)

- Contact input

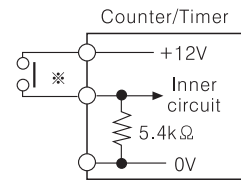

Counting speed :
Set as 1 or 30cps

Input & output connections

- In case of operating the load by power supply of the sensor

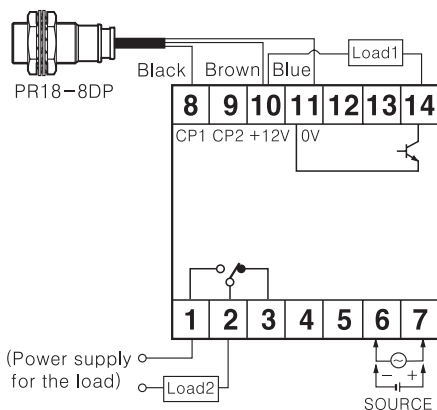

- Please select proper capacity of load, because total value of load capacity and current consumption should not be exceed current capacity (Max. 50mA).

- In case of operating the load by external power supply

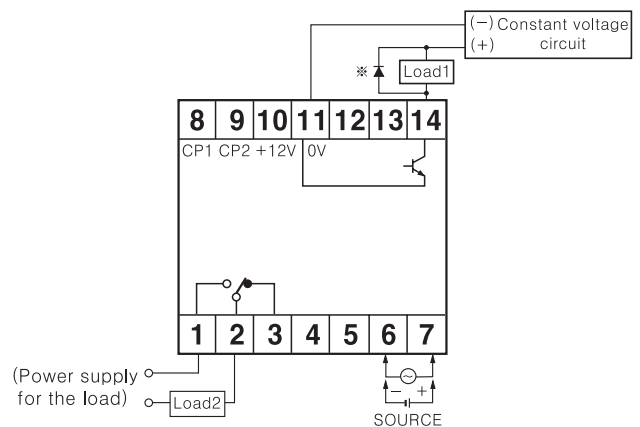

- The capacity of the load must not be exceed Max. 30VDC, Max. 100mA of the switching capacity of the transistor.
- Please do not supply the reverse polarity voltage.
- ※In case of using the inductive load(Relay, etc.), please connector the surge absorber(Diode) at both terminals of the load, in case of using the inductive load.

(A) Counter

(B) Timer

(C) Temp. controller

(D) Power controller

(E) Panel meter

(F) Tacho/Speed/Pulse meter

(G) Display unit

(H) Sensor controller

(I) Switching power supply

(J) Proximity sensor

(K) Photo electric sensor

(L) Pressure sensor

(M) Rotary encoder

(N) Stepping motor & Driver & Controller

(O) Graphic panel

(P) Production stoppage models & replacement

F/L Series

■ Selection by DIP switches

● W72×H72 DIP switch position

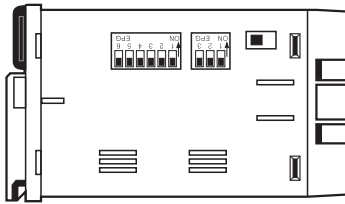

● W144×H72 DIP switch position

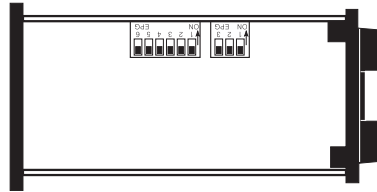

● Memory protection

SW2	Function
ON <input type="checkbox"/> 3 OFF <input type="checkbox"/>	Disable the memory protection
ON <input type="checkbox"/> 3 OFF <input type="checkbox"/>	Enable the memory protection

● Selecting max. counting speed

SW2	Max. counting speed
ON <input type="checkbox"/> 1 2 OFF <input type="checkbox"/>	1cps
ON <input type="checkbox"/> 1 2 OFF <input type="checkbox"/>	30cps
ON <input type="checkbox"/> 1 2 OFF <input type="checkbox"/>	2kcps
ON <input type="checkbox"/> 1 2 OFF <input type="checkbox"/>	5kcps

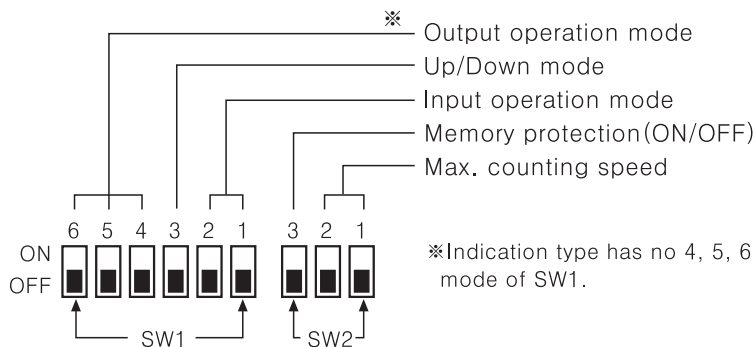

■ Counting function of indication type

● Up mode

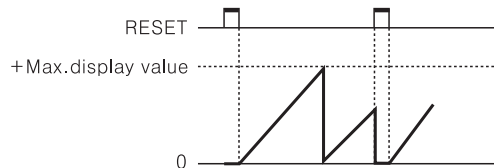

● Down mode

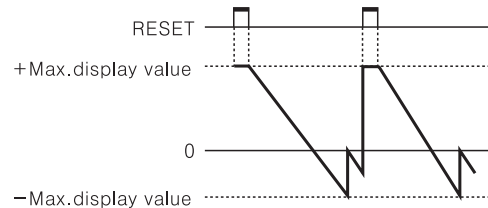

● Up / Down-A, B, C input mode

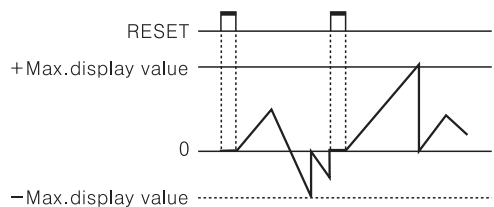

● Up / Down-D, E, F mode

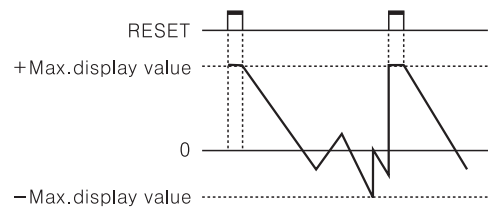

■ Decimal point setting

Display the decimal point.

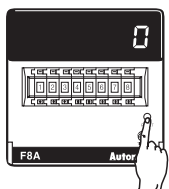

RUN mode

※ It enters to setting mode of decimal point if pressing RESET button for over 3sec.

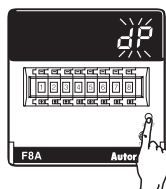

※ When "dp" is flashing, one touch the Reset button.

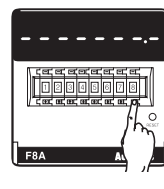

※ Set the position of decimal point using \leftarrow , \rightarrow button of digital switch.

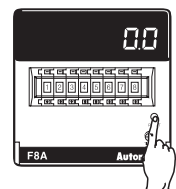

Return to RUN mode

※ It returns to RUN mode if pressing RESET button for over 3sec.

● Changing the decimal point

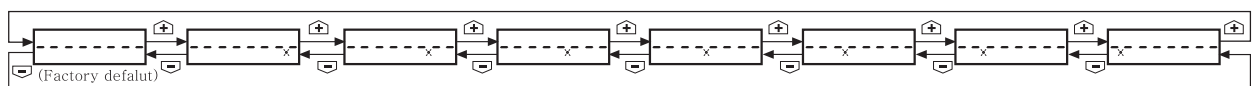

※ It returns to RUN mode if no RESET button or digital switch is applied for 60sec. in decimal point setting status.

※ The decimal point setting is existed in indication type.

8 Digit Up/Down/Up • Down Counter

Input operation mode(Counter)

Input mode(SW1)		SW1	No-voltage input type(NPN)	Voltage input type(PNP)
Up mode ON <input type="checkbox"/> 3 OFF <input checked="" type="checkbox"/>	Up/Down-A (Command input)	ON <input type="checkbox"/> 1 2 OFF <input checked="" type="checkbox"/>		
	Up/Down-B (Individual input)	ON <input type="checkbox"/> 1 2 OFF <input checked="" type="checkbox"/>		
	Up/Down-C (Phase difference input)	ON <input type="checkbox"/> 1 2 OFF <input checked="" type="checkbox"/>		
	Up (Count up input)	ON <input type="checkbox"/> 1 2 OFF <input checked="" type="checkbox"/>		
Down mode ON <input checked="" type="checkbox"/> 3 OFF <input type="checkbox"/>	Up/Down-D (Command input)	ON <input type="checkbox"/> 1 2 OFF <input checked="" type="checkbox"/>		
	Up/Down-E (Individual input)	ON <input type="checkbox"/> 1 2 OFF <input checked="" type="checkbox"/>		
	Up/Down-F (Phase difference input)	ON <input type="checkbox"/> 1 2 OFF <input checked="" type="checkbox"/>		
	Down (Count down input)	ON <input type="checkbox"/> 1 2 OFF <input checked="" type="checkbox"/>		

※ Ⓐ: Over Min. signal width, Ⓞ: Over 1/2 of Min. signal width.

If the signal width of Ⓐ or Ⓞ is less than Min. signal width, ±1 of count error is occurred.

(A) Counter

(B) Timer

(C) Temp. controller

(D) Power controller

(E) Panel meter

(F) Tacho/Speed/Pulse meter

(G) Display unit

(H) Sensor controller

(I) Switching power supply

(J) Proximity sensor

(K) Photo electric sensor

(L) Pressure sensor

(M) Rotary encoder













































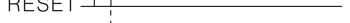
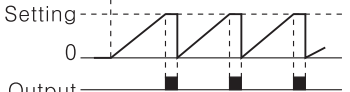



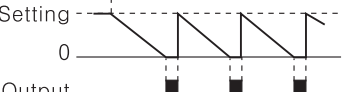



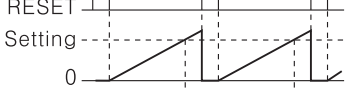



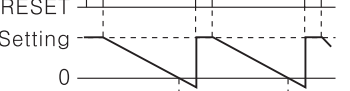







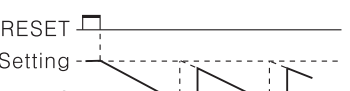



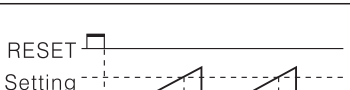



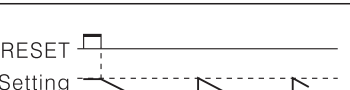





(N) Stepping motor & Driver & Controller

(O) Graphic panel

(P) Production stoppage models & replacement

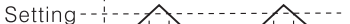
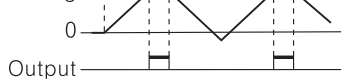
F/L Series

Output operation mode

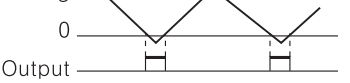
		 ← One-shot output (0.05 ~ 5sec)	 ← Self-holding output	
Output mode (SW1)	ON  Up mode OFF  Down mode			Operation after count up
	Up, Up / Down-A, B, C Down, Up / Down-D, E, F			
F 	RESET  Setting  0  Output 	RESET  Setting  0  Output 	The display value continues until reset signal is applied and the output will be held. • Self-holding output is held until reset signal is applied.	
N 	RESET  Setting  0  Output 	RESET  Setting  0  Output 	The display value and self-holding output are held until reset signal is applied.	
C 	RESET  Setting  0  Output 	RESET  Setting  0  Output 	The display value returns to reset start status when display value is reached to setting value.	
R 	RESET  Setting  0  Output 	RESET  Setting  0  Output 	The display value is held until output is OFF then returns to reset start status.	
K 	RESET  Setting  0  Output 	RESET  Setting  0  Output 	The display value continues until reset signal is applied.	
P 	RESET  Setting  0  Output 	RESET  Setting  0  Output 	The display value is held during one-shot output time, counting process is returned to reset start status when output is ON.	
Q 	RESET  Setting  0  Output 	RESET  Setting  0  Output 	The display value continues during one-shot output time.	
S 	Up input	Down input	• Up, UP/Down-A, B, C input mode -Output is ON when (Display value) ≥ (Setting value) • Down, UP/Down-D, E, F input mode -Output is ON when (Display value) ≤ (Zero)	
	RESET  Setting  0  Output 	RESET  Setting  0  Output 		
	Up, Up / Down-A, B, C	Down, Up / Down-D, E, F		
	RESET  Setting  0  Output 	RESET  Setting  0  Output 		

8 Digit Up/Down/Up • Down Counter

■ Proper usage

◎ Reset function

● Reset

In case of changing the input mode after supplying the power, please take an external reset or manual reset. **If reset is not executed, the counter will be working as previous mode.**

● Reset signal width

It is reset perfectly when the reset signal is applied during **max. 20ms** regardless of the contact input & solid-state input.

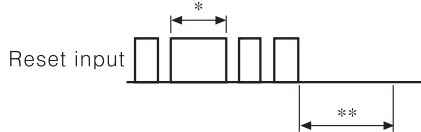

*In case of a contact reset, it is reset perfectly if the ON time of reset signal is applied during max. 20ms even though a chattering is occurred.

**It can be input the signal of CP1 & CP2 after max. 50ms from closing time of reset signal.

◎ Min. signal width of CP1, CP2 input

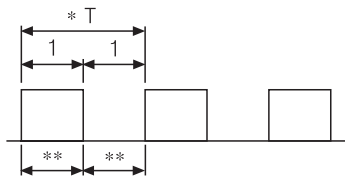

*Please make duty ratio (ON/OFF) as 1:1.

** Min. signal width

1cps	: Max. 500ms
30cps	: Max. 16.7ms
2kcps	: Max. 0.25ms
5kcps	: Max. 0.1ms

◎ Max. counting speed

This is a response speed per 1 sec. when the duty ratio (ON:OFF) of input signal is 1:1. If the duty ratio is not 1:1, the width between ON and OFF should be over min. signal width and the response speed is getting slower against input signal. If either ON or OFF signal is shorter than minimum signal width, this product may not respond.

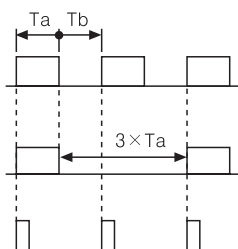

Therefore T_a (ON width) and T_b (OFF width) needed to be over min. signal width.

Max. counting speed is 1/2 value of catalog spec. when duty ratio is 1:3.

It can not respond because Max. signal width (1a) is small.

◎ Error display

Error signal	Error description	Returning method
Err0	Zero setting status	Change the setting value to non zero status

*When Error is displayed, the output continues OFF state.
*There is no Error function in the indication type.

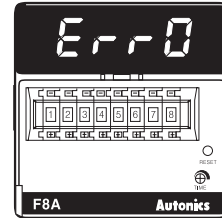

◎ Power

The inner circuit voltage starts to rise up for the first 100ms after power on, the input may not work at this time. And also the inner circuit voltage drops down for the last 500ms after power off, the input may not work at this time.

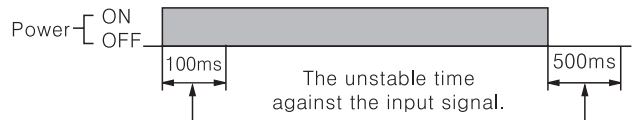

■ Case & DIP switch detachment

● F Series

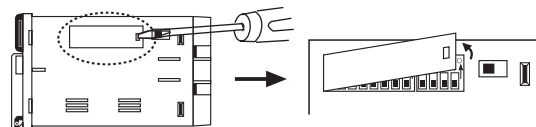

Push a lock part to front direction and widen it simultaneously.

*Please be careful to use with tools, it may cause injury.

● L Series

Please turn off the power before detaching the case.

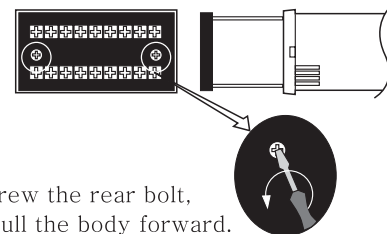

Unscrew the rear bolt, and pull the body forward.

(A) Counter

(B) Timer

(C) Temp. controller

(D) Power controller

(E) Panel meter

(F) Tacho/Speed/Pulse meter

(G) Display unit

(H) Sensor controller

(I) Switching power supply

(J) Proximity sensor

(K) Photo electric sensor

(L) Pressure sensor

(M) Rotary encoder

(N) Stepping motor & Driver & Controller

(O) Graphic panel

(P) Production stoppage models & replacement