

Up/Down Counter/Timer

DIN W72 × H72, W48 × H96, W144 × H72mm COUNTER/TIMER

■ Features

- Easy to select 36 kinds of input operation mode or 20 output operation modes by internal DIP switch.
- Upgraded counting speed: **1cps / 30cps / 2kcps / 5kcps**
- Selectable voltage input (PNP) or No voltage input (NPN)
- Addition of Up/Down input mode
- Wide range of power supply :
100–240VAC 50/60Hz, **12–24VAC/DC**
- Selectable Counter/Timer by internal DIP switch
- Various time range
- Built-in Microprocessor



⚠ Please read "Caution for your safety" in operation manual before using.



■ Specifications

※ Blacked () items are upgraded function.

Model	Single preset	FX4	FX6	FX4H	_____	_____
	Dual preset	FX4-2P	FX6-2P	FX4H-2P	FX4L-2P	FX6L-2P
	Indication	FX4-I	FX6-I	FX4H-I	FX4L-I	FX6L-I
Digit		4	6	4	4	6
Digit size		W8×H14mm	W4×H8mm	W6×H10mm	W8×H14mm	
Power supply	100–240VAC 50/60Hz, 12–24VAC/DC					
Allowable voltage range	90 ~ 110% of rated voltage					
Power consumption	<ul style="list-style-type: none"> • Indicator : Approx. 6VA (240VAC 60Hz), Approx. 2.7W (24VDC), Approx. 5.8VA (24VAC 60Hz) • Single preset : Approx. 7VA (240VAC 60Hz), Approx. 3.3W (24VDC), Approx. 6.8VA (24VAC 60Hz) • Dual preset: Approx. 8VA (240VAC 60Hz), Approx. 3.8W (24VDC), Approx. 7.6VA (24VAC 60Hz) 					
Max. counting speed for CP1, CP2	Selectable 1cps/30cps/2kcps/5kcps by internal DIP switch					
Min. input signal width	RESET input	Approx. 20ms				
	INHIBIT input					
Input	CP1, CP2 input (INHIBIT)	Input logic is selectable				
	RESET input	[Voltage input] Input impedance : 5.4kΩ, "H" level : 5–30VDC, "L" level : 0–2VDC [No-voltage input] Impedance at short-circuit : Max. 1kΩ, Residual voltage at short-circuit : Max. 2VDC, Impedance at open-circuit : Min. 100kΩ				
One-shot output time	<ul style="list-style-type: none"> • Single preset type ☞ 0.05~5sec • Dual preset type ☞ 1st. output 0.5sec fixed, 2st. output : 0.05~5sec 					
Control output	Contact	Type	Single preset type : SPDT(1c), Dual preset type : 1st output SPDT(1c), 2nd output SPDT(1c)			
		Capacity	250VAC 3A at resistive load			
	Solid-state	Type	Single preset type : 1 NPN open collector Dual preset type : 1st output 1 NPN open collector, 2nd output 1 NPN open collector			
		Capacity	30VDC Max. 100mA Max.			
Memory protection	10 years (When using non-volatile semiconductor memory)					
External sensor power	12VDC ±10% 50mA Max.					
Ambient temperature	-10 ~ +55°C (at non-freezing status)					
Storage temperature	-25 ~ +65°C (at non-freezing status)					
Ambient humidity	35 ~ 85%RH					
Insulation resistance	Min. 100MΩ (at 500VDC)					
Dielectric strength	2000VAC 50/60Hz for 1 minute					
Noise strength	AC power	±2kV the square wave noise (pulse width:1μs) by the noise simulator				
	DC power	±500V the square wave noise (pulse width:1μs) by the noise simulator				

(A) Counter

(B) Timer

(C) Temp. controller

(D) Power controller

(E) Panel meter

(F) Tacho/Speed/Pulse meter

(G) Display unit

(H) Sensor controller

(I) Switching power supply

(J) Proximity sensor

(K) Photo electric sensor

(L) Pressure sensor

(M) Rotary encoder

(N) Stepping motor & Driver & Controller

(O) Graphic panel

(P) Production stoppage models & replacement

FX/FXH/FXL Series

Specifications

Vibration	Mechanical	0.75mm amplitude at frequency of 10 ~ 55Hz in each of X, Y, Z directions for 1 hour				
	Malfunction	0.5mm amplitude at frequency of 10 ~ 55Hz in each of X, Y, Z directions for 10 minutes				
Shock	Mechanical	300m/s ² (Approx. 30G) in X, Y, Z directions for 3 times				
	Malfunction	100m/s ² (Approx. 10G) in X, Y, Z directions for 3 times				
Relay life cycle	Mechanical	Min. 10,000,000 operations				
	Electrical	Min. 100,000 operations at 250VAC 2A (resistive load)				
Approval						
Unit weight		FX4 : Approx. 295g FX4-2P : Approx. 305g FX4-I : Approx. 260g	FX6 : Approx. 305g FX6-2P : Approx. 315g FX6-I : Approx. 265g	FX4H : Approx. 325g FX4H-2P : Approx. 353g FX4H-I : Approx. 297g	FX4L-2P : Approx. 544g FX4L-I : Approx. 455g	FX6L-2P : Approx. 550g FX6L-I : Approx. 461g

*Qualification mark for FX4, FX4-I, FX6, FX6-I.

Connections

FX□-2P

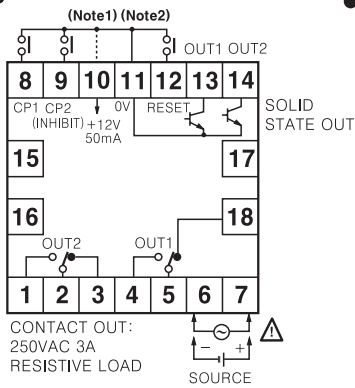

FX□

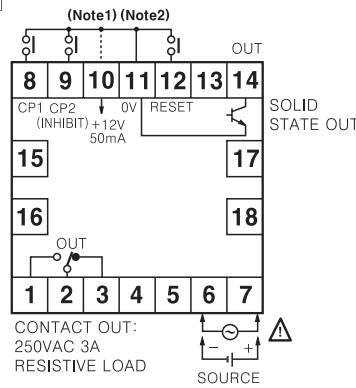

FX□-I

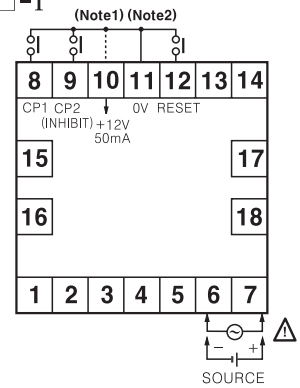

FX4H-2P

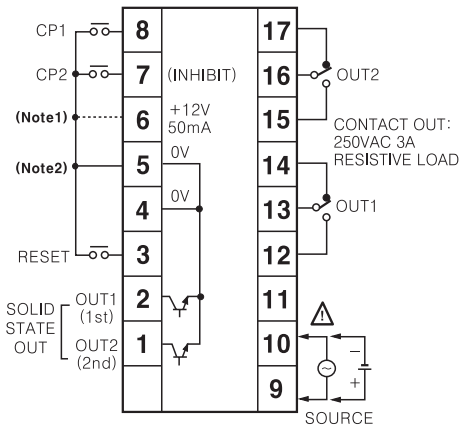

FX4H

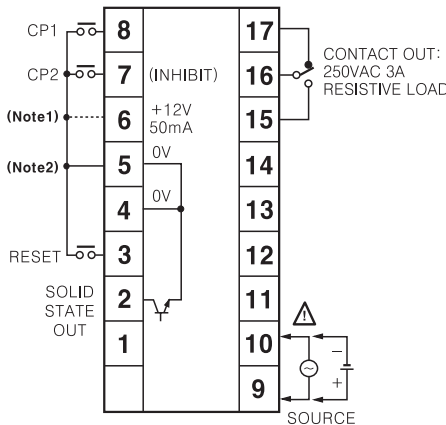

FX4H-I

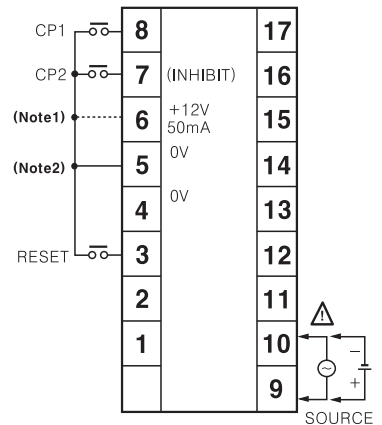

FX□L-2P

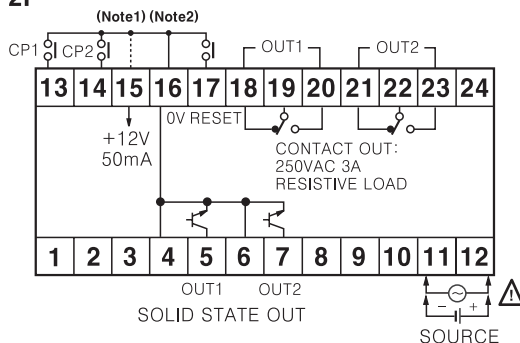

FX□L-I

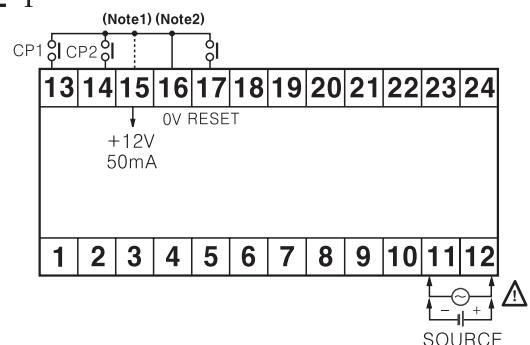

*CP2(INHIBIT) : Time hold terminal when using for timer.
*It is operated by power ON start type when using for timer.

* (Note1) : Connection for PNP input
* (Note2) : Connection for NPN input

Up/Down Counter/Timer

Dimensions

●FX Series

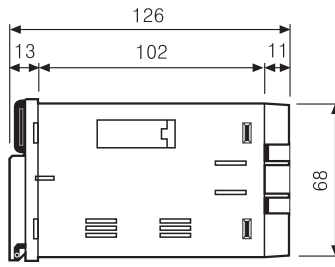
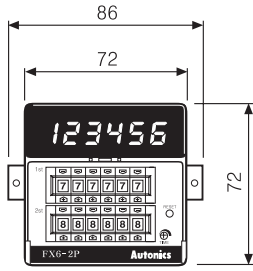

●Panel cut-out

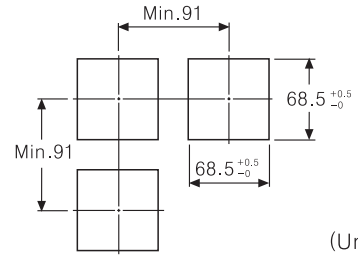

(Unit:mm)

●FXH Series

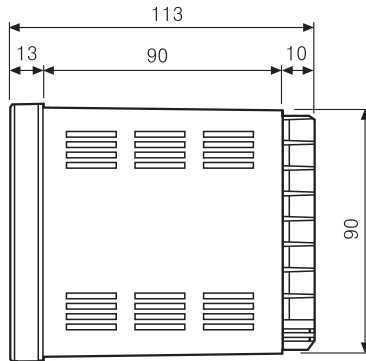
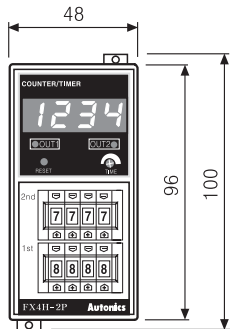

●Panel cut-out

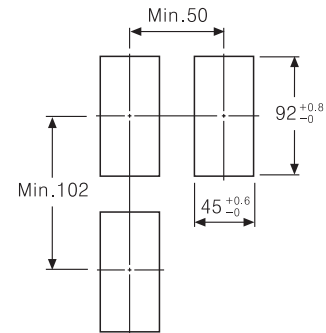

(Unit:mm)

●FXL Series

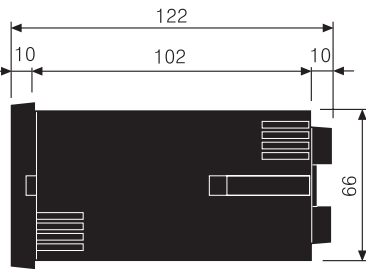
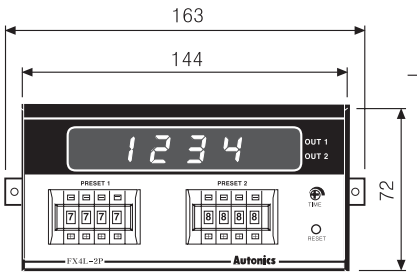

●Panel cut-out

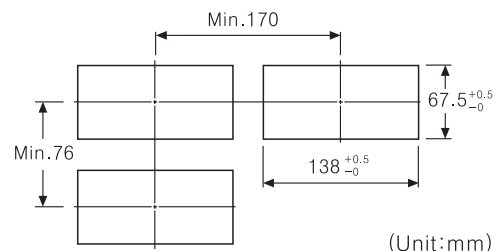

(Unit:mm)

Input connections

◎No-voltage input(NPN)

●Solid-state input(Standard input sensor : NPN output type sensor)

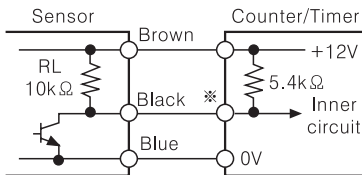

(NPN output)

*CP1, CP2(INHIBIT), RESET input

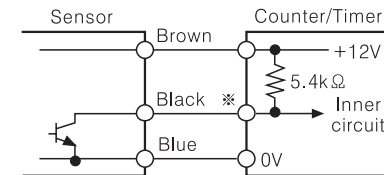

(NPN open collector output)

●Contact input

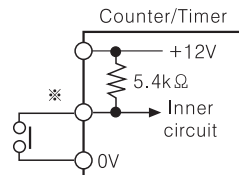

Counting speed :
1 or 30cps setting(Counter)

◎Voltage input(PNP)

●Solid-state input(Standard input sensor : PNP output type sensor)

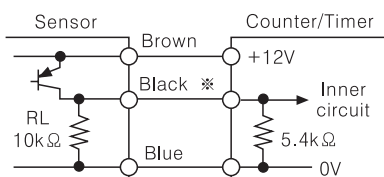

(PNP output)

*CP1, CP2(INHIBIT), RESET Input

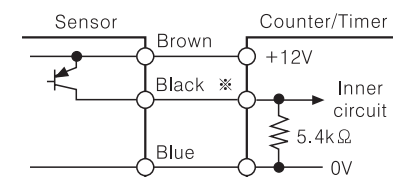

(PNP open collector output)

●Contact input

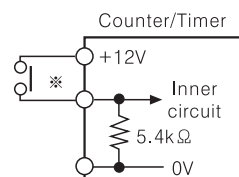

Counting speed :
1 or 30cps setting(Counter)

(A)
Counter

(B)
Timer

(C)
Temp.
controller

(D)
Power
controller

(E)
Panel
meter

(F)
Tacho/
Speed/
Pulse
meter

(G)
Display
unit

(H)
Sensor
controller

(I)
Switching
power
supply

(J)
Proximity
sensor

(K)
Photo
electric
sensor

(L)
Pressure
sensor

(M)
Rotary
encoder

(N)
Stepping
motor &
Driver &
Controller

(O)
Graphic
panel

(P)
Production
stoppage
models &
replacement

FX/FXH/FXL Series

Input logic selection

●FX series

Input logic is changeable by input logic selection switch located at the one-side of case.

- No voltage input (NPN)
- Voltage input (PNP)

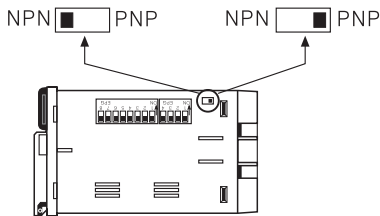

●FXL series

Input logic is changeable by input logic selection switch located at the terminal block.

- No voltage input (NPN)
- Voltage input (PNP)



●FXH series

Input logic is changeable by input logic selection switch (SW3) located at inside of the case.

- No voltage input (NPN)
- Voltage input (PNP)

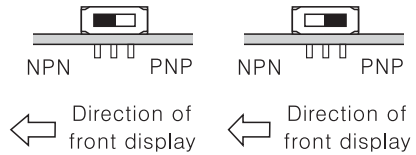

※Please be sure to turn power OFF before changing input logic.

Input & output connections

◎In case of operating the load by power supply of the sensor

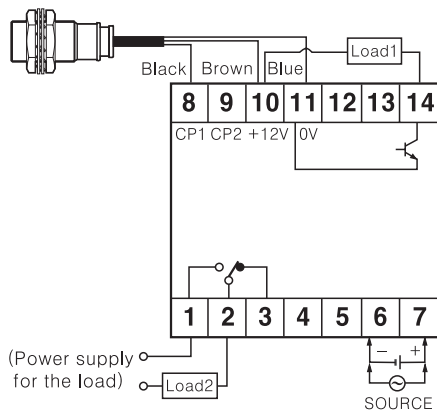

- Please select proper capacity of load, because total value of load capacity and current consumption should not be exceed current capacity. (Max. 50mA)

◎In case of operating the load by external power supply

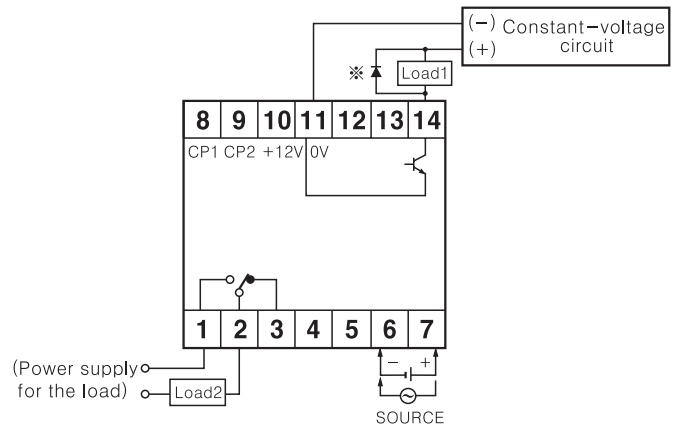

- The capacity of the load must not exceed max. 30VDC, max. 100mA of the switching capacity of the transistor.
- Please do not supply the reverse polarity voltage.
- ※Please connector the surge absorber (Diode) at both terminals of the load, in case of using the inductive load. (Relay, etc.)

◎How to count by external power supply

This unit starts to count when "High" level (5-30VDC) is applied at CP1 or CP2 after selecting PNP.

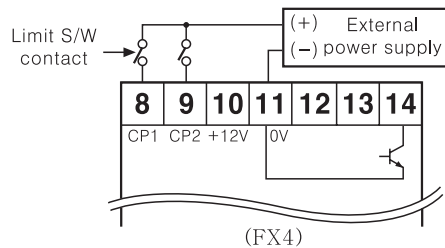

◎Using 2 counters with one sensor

- Please connect as the power of sensor is supplied from only one of counters and design input logic with same way.

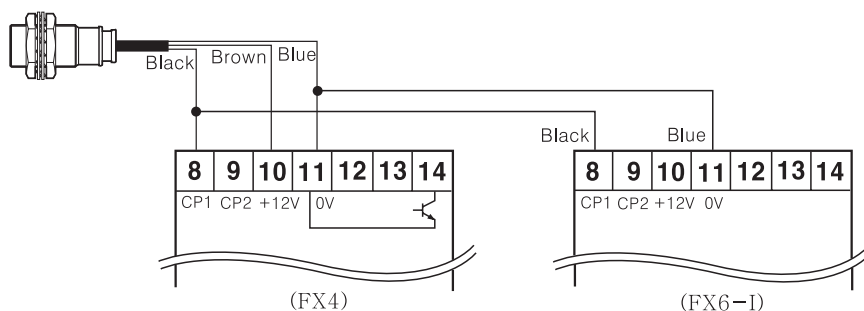

Up/Down Counter/Timer

■ Selection by DIP switches

● 72×72 DIP switch position

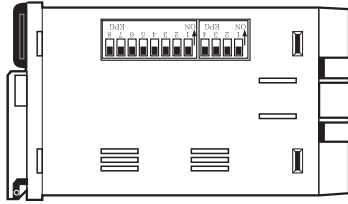

● 48×96 DIP switch position

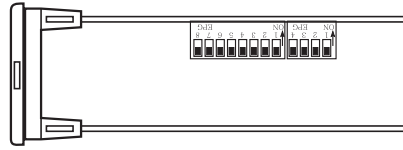

● 144×72 DIP switch position

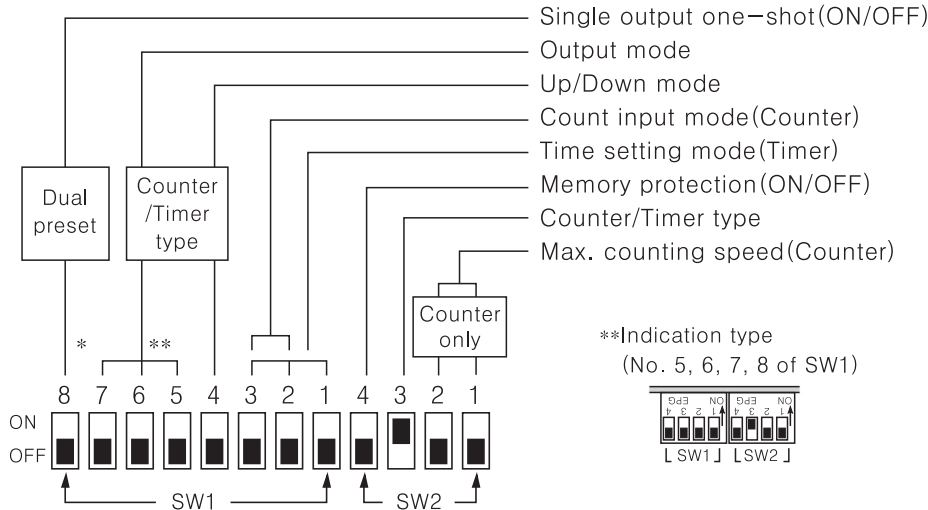
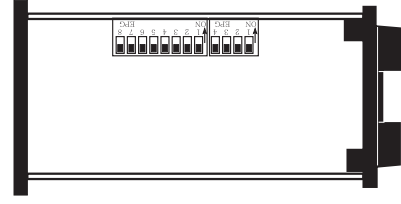

● Max. counting speed

SW2	Functions
1 ON, 2 ON	1cps
1 ON, 2 OFF	30cps
1 OFF, 2 ON	2kcps
1 OFF, 2 OFF	5kcps

● Conter/Timer

SW2	Functions
3 ON	Conter
3 OFF	Timer

● Up/Down mode

SW1	Functions
4 ON	Down mode
4 OFF	Up mode

● Memory protection

SW2	Functions
4 ON	Disable the memory protection
4 OFF	Enable the memory protection

● Selection of one-shot output or self-holding output for 1st output.

SW1	Function
8 ON	1st output : One-shot output
8 OFF	1st output : Self-holding output

※ This mode selects a one-shot output (0.5sec fixed) or self-holding output (Until 2nd output turns off) for 1st output in the dual preset counter.

※ Example of F output operation mode

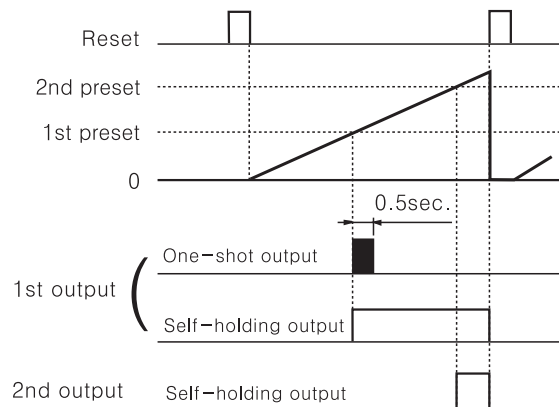

(A) Counter

(B) Timer

(C) Temp. controller

(D) Power controller

(E) Panel meter

(F) Tacho/Speed/Pulse meter

(G) Display unit

(H) Sensor controller

(I) Switching power supply

(J) Proximity sensor

(K) Photo electric sensor

(L) Pressure sensor

(M) Rotary encoder







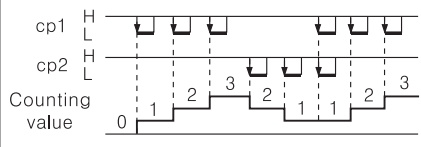
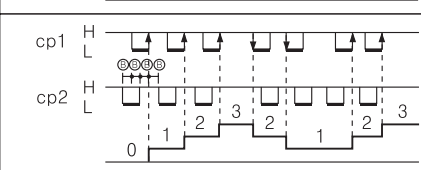

(N) Stepping motor & Driver & Controller

(O) Graphic panel

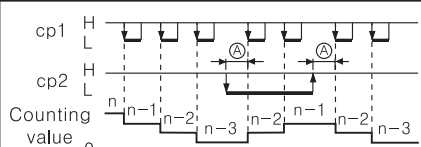
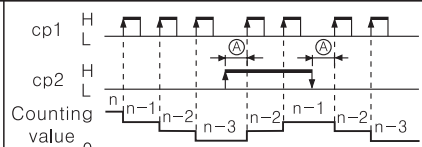
(P) Production stoppage models & replacement

FX/FXH/FXL Series

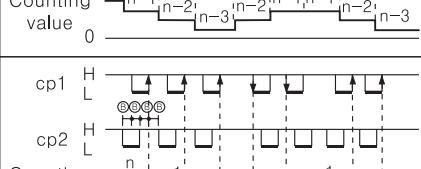
Input operation(Counter)

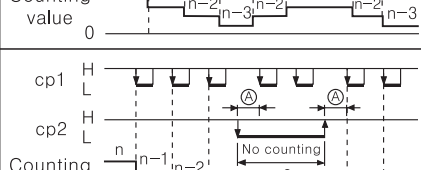
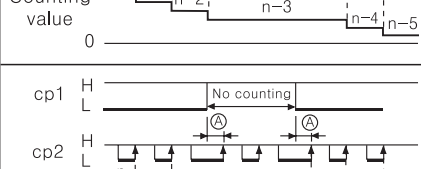
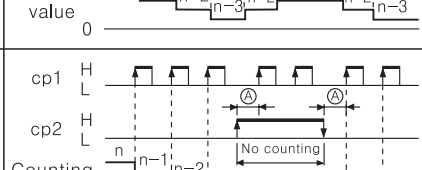
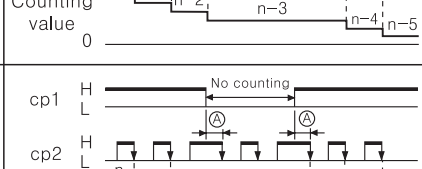
Input mode		SW1	No-voltage input type(NPN)	Voltage input type(PNP)
Up mode	Up/Down-A (Command input)	ON  OFF 		
	Up/Down-B (Individual input)	ON  OFF 		
	Up/Down-C (Phase difference input)	ON  OFF 		
	Up (Count up input)	ON  OFF 	 	 
Down mode	Up/Down-D (Command input)	ON  OFF 		
	Up/Down-E (Individual input)	ON  OFF 		
	Up/Down-F (Phase difference input)	ON  OFF 		
	Down (Count down input)	ON  OFF 	 	 

※ Ⓐ : Over Min. signal width, Ⓑ : Over 1/2 of Min. signal width.

If the signal width of Ⓐ or Ⓑ is less than Min. signal width, ±1 of count error is occurred.

Up/Down Counter/Timer

Time setting mode(timer)

	SW1	4Digit	6Digit
A		99.99sec	99999.9sec
B		999.9sec	999999sec
C		9999sec	99min 59.99sec
D		99min 59sec	999min 59.9sec
E		999.9min	99999.9min
F		99hour 59min	99hour 59min 59sec
G		999.9hour	9999hour 59min
H		9999hour	99999.9hour

Counting operation of indication type(Counter)

Up mode

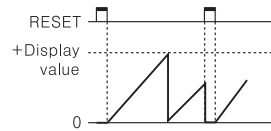

Down mode

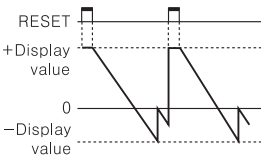

Up / Down-A, B, C mode

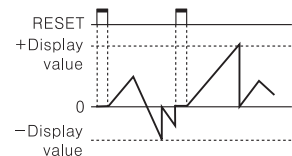

Up / Down-D, E, F mode

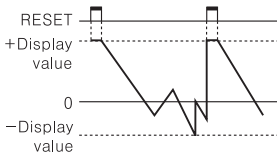

Time operation of indication type (Timer)

Up mode

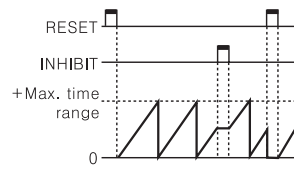

Down mode

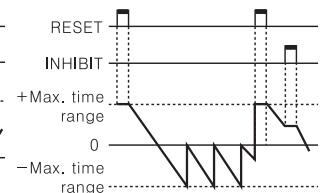

Decimal point setting

Display the decimal point.

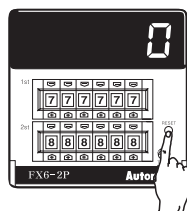

RUN mode

※It enters to setting mode of decimal point if pressing RESET button for over 3sec.

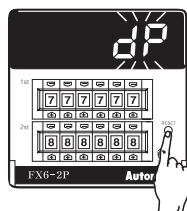

※When "dP" is flashing, one touch the Reset button.

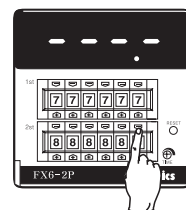

※Set the position of decimal point using \uparrow , \downarrow buttons of digital switch.

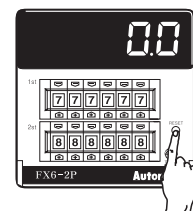

Return to RUN mode

※It returns to RUN mode if pressing RESET button for over 3sec

Changing the decimal point

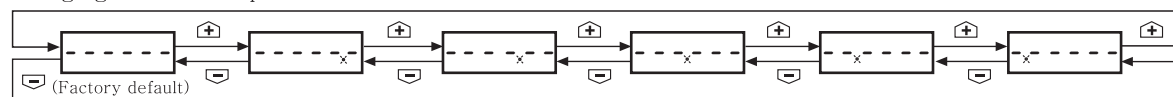

※It returns to RUN mode if no RESET button or digital switch is applied for 60sec. in decimal point. Setting status.
 ※The decimal point setting is not existed in indication type.

(A) Counter

(B) Timer

(C) Temp. controller

(D) Power controller

(E) Panel meter

(F) Tacho/Speed/Pulse meter

(G) Display unit

(H) Sensor controller

(I) Switching power supply

(J) Proximity sensor

(K) Photo electric sensor

(L) Pressure sensor

(M) Rotary encoder



(N) Stepping motor & Driver & Controller















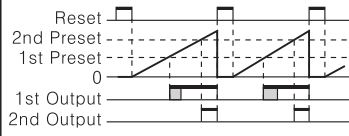
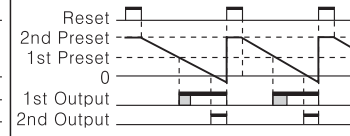

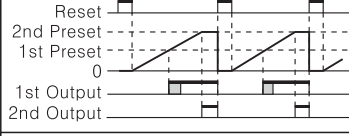
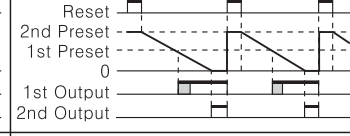

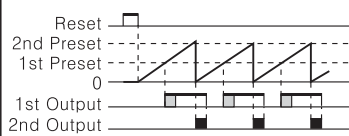
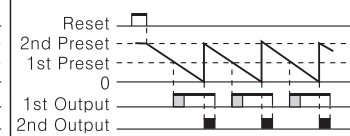

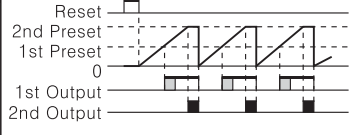
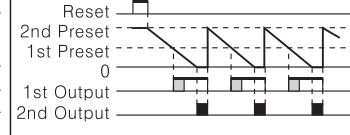
(O) Graphic panel

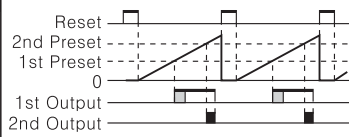
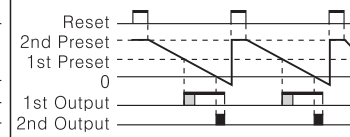
(P) Production stoppage models & replacement

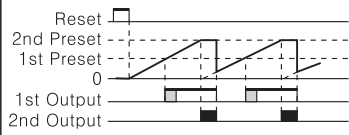
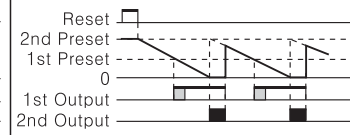
FX/FXH/FXL Series

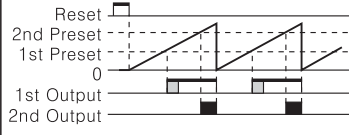
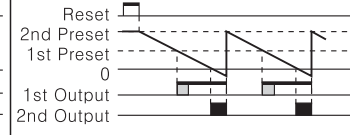
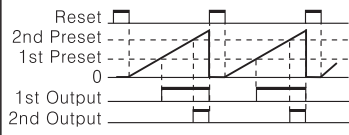
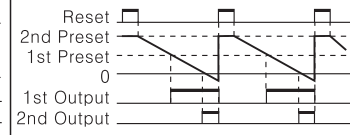
Output operation mode

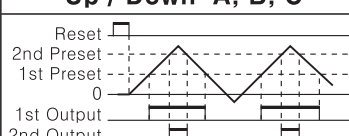
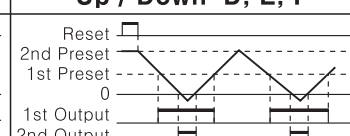
 One-shot output (0.05-5sec) of 2nd output
  Self-holding output
  Self-holding output
 *The output of single preset type is operated at the status of the second output mode

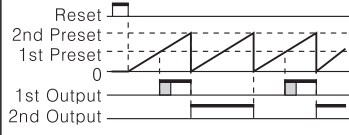
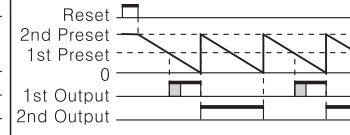
Output mode (SW1)	ON  Up mode	ON  Down mode	Operation after count up
	Up, Up / Down-A, B, C	Down, Up / Down-D, E, F	
F ON  OFF 			The display value continues until Reset signal applied and the output is held. • 1st self-holding output and 2nd output is held until Reset signal applied. • When using 1st output as one-shot output, it will return after operating for 0.5sec.
N ON  OFF 			The display value and output will be held until Reset input is applied.
C ON  OFF 			The display value will be Reset Start status as soon as it reaches to 2nd setting value. • 1st self-holding output will be OFF after one-shot output time of 2nd output. • 1st one-shot output will be reset after operating 0.5sec., and it is not related to 2nd output.
R ON  OFF 			The display value will be held until 2nd output is OFF then reset. • 1st hold output will be OFF after one-shot time of 2nd output. • 1st one-shot output will be reset after operating 0.5sec., and it is not related to 2nd output.
K ON  OFF 			The display value continues until Reset signal applied. • 1st hold output will be OFF after one-shot time of 2nd output. • 1st one-shot output will be reset after operating 0.5sec., and it is not related to 2nd output.
P ON  OFF 			The display value will be Reset Start status as soon as it reaches to 2nd setting value. • 1st hold output will be OFF after one-shot time of 2nd output. • 1st one-shot output will be reset after operating 0.5sec., and it is not related to 2nd output.
Q ON  OFF 			The display continues until 2nd output is OFF. • 1st hold output will be OFF after one-shot time of 2nd output. • 1st one-shot output will be reset after operating 0.5sec. not related to 2nd output.
S	Up 	Down 	• Up, Up/Down-A, B, C input mode -OUT1 is ON when (Display value) ≥ (1st setting value) -OUT2 is ON when (Display value) ≥ (Dual setting value) • Down, Up/Down-D, E, F input mode -OUT1 is ON when (Display value) ≤ (1st setting value) -OUT2 is ON when (Display value) ≤ (Zero)
Counter ON  OFF 	Up / Down-A, B, C 	Up / Down-D, E, F 	
S Timer ON  OFF 			When it is used as Timer, 1st output and 2nd output are flickering repeatedly.

Up/Down Counter/Timer

■ Proper usage

○ Reset

● Reset

In case of changing the input mode after supplying the power, please provide an external reset or manual reset. **If reset is not executed, the counter will be working in previous mode.**

● Reset signal width

To guarantee proper reset, the signal must be supplied for a minimum of **min. 20ms** regardless the signal comes from a contact or a solid-state input.

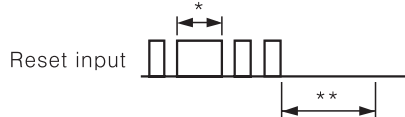

*In case of a contact reset, contact chattering will not affect the reset as long as it is applied for a minimum of 20ms.

**Input signal at CP1 & CP2 must be applied for a minimum of 50ms after the reset is removed.

○ Minimum count signal width

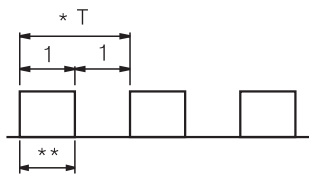

* Please make duty ratio(ON/OFF) as 1:1.

**Minimum signal width $\left[\begin{array}{l} 30\text{cps} : \text{Min. } 16.7\text{ms} \\ 2\text{kcps} : \text{Min. } 0.25\text{ms} \end{array} \right.$

○ Maximum counting speed

This is a response speed per 1 sec. when the duty ratio (ON:OFF) of input signal is 1:1. If the duty ratio is not 1:1, the width between ON and OFF should be over min. signal width and the response speed will getting slower against input signal. If either ON or OFF signal is shorter than minimum signal width, this product may not respond.

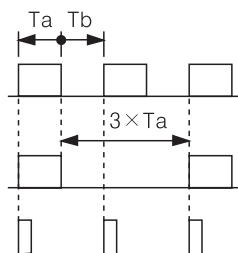

Therefore Ta(ON width) and Tb(OFF width) needed to be over min.signal width.

Max. counting speed is 1/2 value of catalog spec. when duty ratio is 1:3.

It can not respond because Max. signal width(1a) is small.

○ Power

The inner circuit voltage starts to rise up for the first 100ms after power on, the input may not work at this time. And also the inner circuit voltage drops down for the last 500ms after power off, the input may not work at this time.

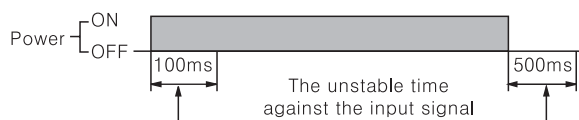

○ INHIBIT(Only Timer)

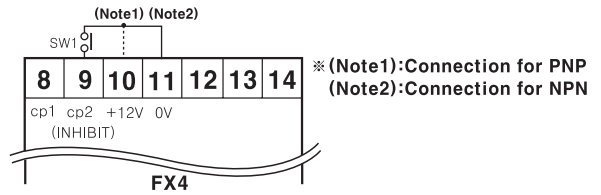

- INHIBIT mode is active when SW1 turns ON. (Time Hold)
- When power is applied, it starts to progress and INHIBIT mode is used to stop the time is under the progress at the moment.
- When SW1 is OFF, timer starts to progress again.

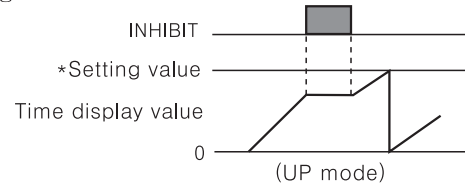

○ How to use the sticker

The below sticker can be found inside the box. Use the sticker according to application as follow:
Ex1) Measurement of length by the rotary encoder EX2) Timer[F mode]

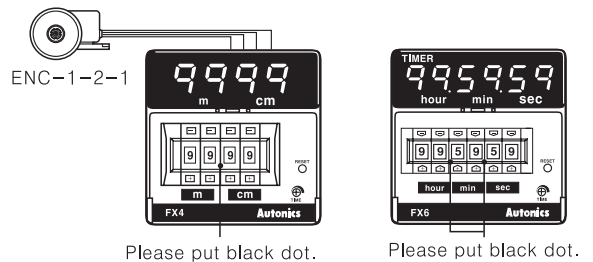

Please put black dot.

Please put black dot.

○ Error display

Error signal	Error description	Returning method
Err0	Zero setting status	Change the setting value to non zero status
	When 2nd setting value is smaller than 1st setting value	Make 2nd setting value bigger than 1st setting value

- * There is no Error display function in indication type.
- * When Error is displayed, the output continues OFF state.

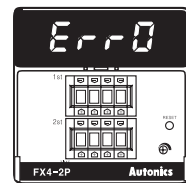
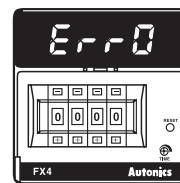

■ Case & DIP switch detachment

● FXH Series

- 1) Push down the front guide.
- 2) Pull out the front guide.

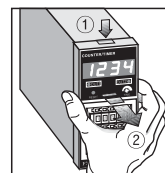

* Separate the case by hands.

● FXL Series



Unscrew the rear bolt, and pull the body backward.

(A) Counter

(B) Timer

(C) Temp. controller

(D) Power controller

(E) Panel meter

(F) Tacho/Speed/Pulse meter

(G) Display unit

(H) Sensor controller

(I) Switching power supply

(J) Proximity sensor

(K) Photo electric sensor

(L) Pressure sensor

(M) Rotary encoder

(N) Stepping motor & Driver & Controller

(O) Graphic panel

(P) Production stoppage models & replacement