

# Up/Down Counter/Timer

## DIN W48 × H48mm, Preset Counter/Timer

### ■ Features

- Upgraded counting speed : **1cps/30cps/2kcps/5kcps**
- Selectable voltage input (PNP) or No voltage input (NPN)
- Addition of Up/Down input mode
- Available to set a decimal point (Fixed decimal point of display)
- Wide range of input power supply :  
100–240VAC 50/60Hz, **12–24VAC/DC** (Option)
- Selectable Counter/Timer by internal DIP switch
- Various time range
- Built-in Microprocessor



**⚠ Please read "Caution for your safety" in operation manual before using.**



### ■ Specifications

※ A blacked (  ) item is upgraded function.

Model	Single preset		FX4S		_____	
	Dual preset		_____		FX5S-I	
Digit			4		5	
Digit size			W4 × H8mm			
Power supply			100–240VAC 50/60Hz, <b>12–24VAC/DC</b> (Option)			
Allowable voltage range			90 ~ 110% of rated voltage			
Power consumption			<ul style="list-style-type: none"> <li>• Indication type : Approx. 4.7VA (240VAC 60Hz), Approx. 5.6VA (24VAC 60Hz), Approx. 2.8W (24VDC)</li> <li>• single preset : Approx. 5.7VA (240VAC 60Hz), Approx. 4.5VA (24VAC 60Hz), Approx. 3W (24VDC)</li> </ul>			
<b>Max. counting speed for CP1, CP2</b>			<b>Selectable 1cps/30cps/2kcps/5kcps by internal DIP switch</b>			
Min. input signal width	INHIBIT input		Approx. 20ms			
	RESET input					
Input	CP1, CP2 input (INHIBIT)		<b>Input logic is selectable</b> [Voltage input] Input impedance : 5.4kΩ "H" level : 5–30VDC, "L" level : 0–2VDC [No-voltage input] Impedance at short-circuit : Max. 1kΩ, Residual voltage at short-circuit : Max. 2VDC, Impedance at open-circuit : Max. 100kΩ			
	RESET input					
<b>One-shot output time</b>			0.05 ~ 5sec		_____	
Control output	Contact	Type	SPDT(1c)			
		Capacity	250VAC 3A at resistive load			
	Solid-state	Type	NPN open collector			
		Capacity	30VDC Max. 100mA Max.			
Memory protection			10 years (When using non-volatile semiconductor memory)			
External power			12VDC ± 10% 50mA Max.			
Dielectric strength			Min. 100MΩ (at 500VDC)			
Insulation resistance			2000VAC 50/60Hz for 1 minute			
Noise strength	AC power		± 2kV the square wave noise (pulse width: 1μs) by the noise simulator			
	DC power		± 500V the square wave noise (pulse width: 1μs) by the noise simulator			
Vibration	Mechanical		0.75mm amplitude at frequency of 10 ~ 55Hz in each of X, Y, Z directions for 1 hour			
	Malfunction		0.5mm amplitude at frequency of 10 ~ 55Hz in each of X, Y, Z directions for 10 minutes			
Shock	Mechanical		300m/s <sup>2</sup> (Approx. 30G) in X, Y, Z directions for 3 times			
	Malfunction		100m/s <sup>2</sup> (Approx. 10G) in X, Y, Z directions for 3 times			
Relay life cycle	Mechanical		Min. 10,000,000 times			
	Electrical		Min. 100,000 times (250VAC 3A at resistive load)			
Ambient temperature			-10 ~ +55°C (at non-freezing status)			
Storage temperature			-25 ~ +65°C (at non-freezing status)			
Ambient humidity			35 ~ 85%RH			
Unit weight			AC type : Approx. 147g, DC type : Approx. 153g		AC type : Approx. 137g, DC type : Approx. 143g	
Approval						

(A) Counter

(B) Timer

(C) Temp. controller

(D) Power controller

(E) Panel meter

(F) Tacho/Speed/Pulse meter

(G) Display unit

(H) Sensor controller

(I) Switching power supply

(J) Proximity sensor

(K) Photo electric sensor

(L) Pressure sensor

(M) Rotary encoder

(N) Stepping motor & Driver & Controller

(O) Graphic panel

(P) Production stoppage models & replacement

# FXS Series

## Connections

### ●FX4S

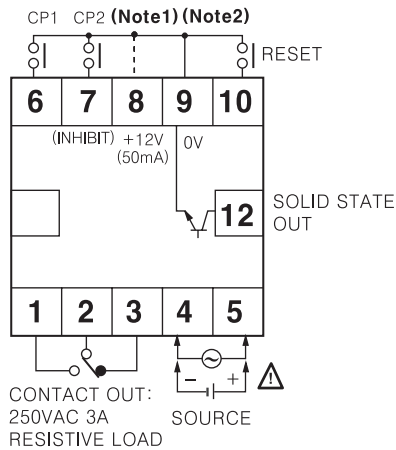

### ●FX5S-I

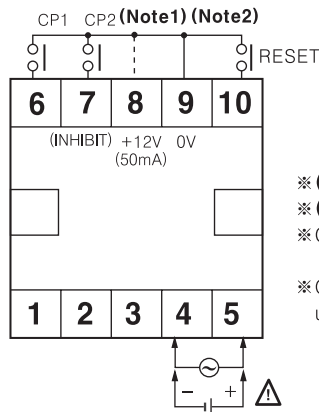

- ※ (Note1) : Connection of PNP input
- ※ (Note2) : Connection of NPN input
- ※ CP2(INHIBIT): Time Hold terminal when using for timer.
- ※ Operated by a power ON start when it is used as a timer.

## Dimensions

### ●Bracket

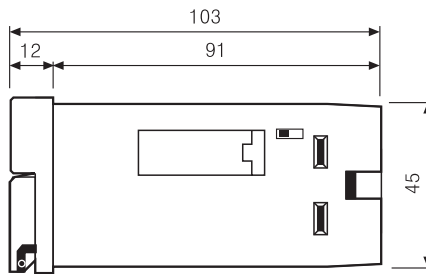
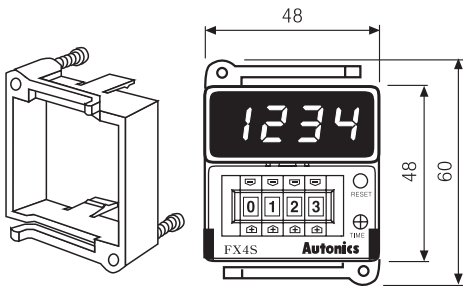

### ●Panel cut-out

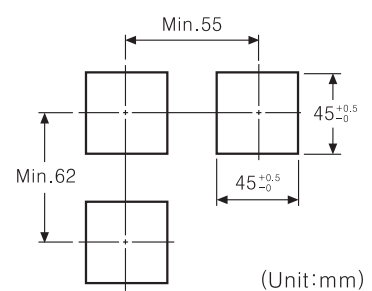

(Unit:mm)

## Input connections

### ◎Input logic : No-voltage(NPN) input

#### ●Solid-state input(Standard sensor : NPN output type sensor)

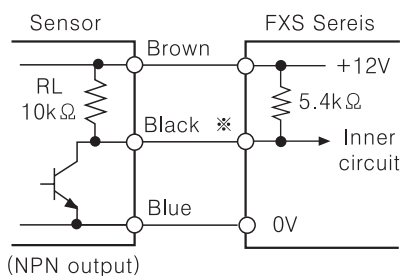

※CP1, CP2(INHIBIT), RESET input

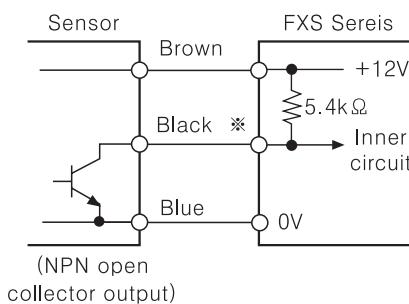

#### ●Contact input

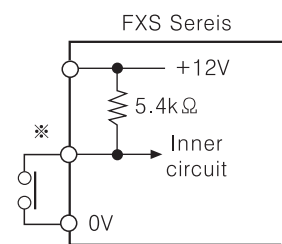

※Please select the counting speed as 30cps when it is used for counter.

### ◎Input logic : Voltage(PNP) input

#### ●Solid-state input(Standard sensor : PNP output type sensor)

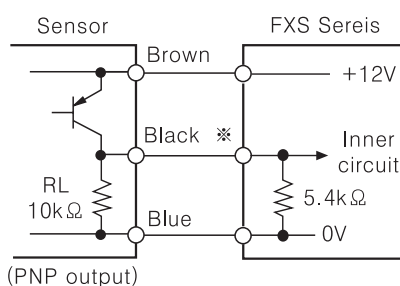

※CP1, CP2(INHIBIT), RESET input

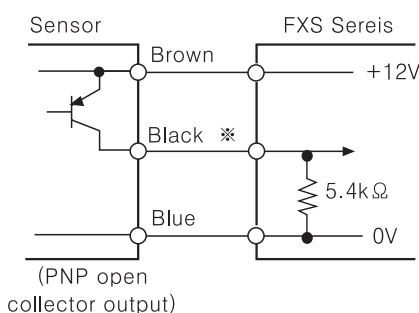

#### ●Contact input

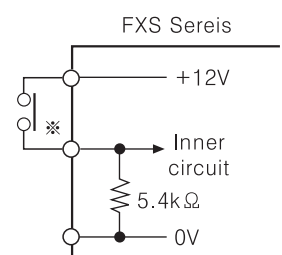

※Please select the counting speed as 30cps when it is used for counter.

# Up/Down Counter/Timer

## Input logic selection

● Select NPN (No-voltage input)

● Select PNP (Voltage input)

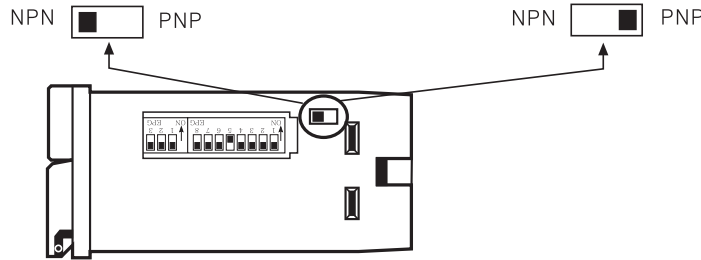

※ Please be sure to turn OFF the power before changing input logic.

## Input & Output connections

○ In case of operating the load by power supply of the sensor

○ In case of operating the load by external power supply

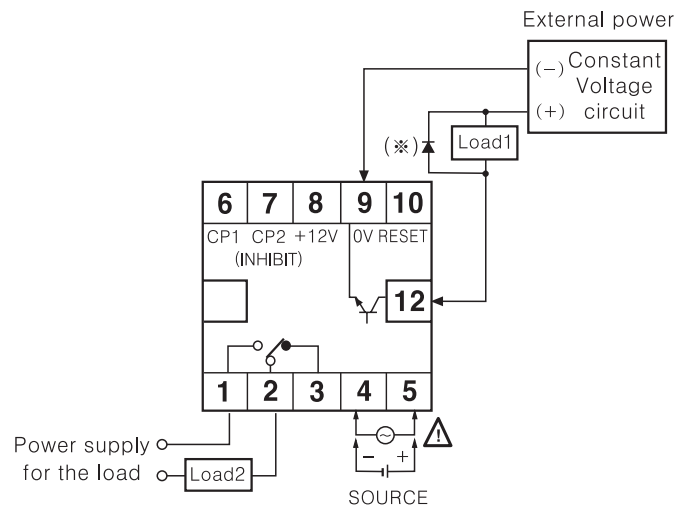
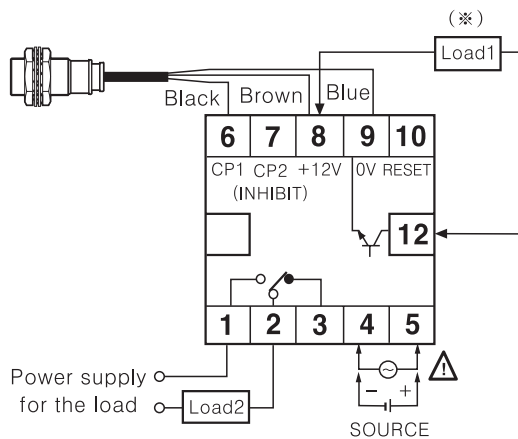

● (\*) Please select proper capacity of load, because total current consumption should not exceed current capacity. (Max. 50mA)

● Contact capacity : Max. 250VAC 3A

● The capacity of Load1 must not exceed Max. 30VDC, Max. 100mA of the switching capacity of the transistor.

● Please do not supply the reverse polarity voltage.

● (\*) Please connect the surge absorber (Diode) at both terminals of Load1, in case of using the inductive load. (Relay, etc.)

○ Using 2 counters with one sensor

● It is available to use 2 counters with one sensor.

Please connect as the power of sensor is supplied from only one of counters and design input logic with same way.

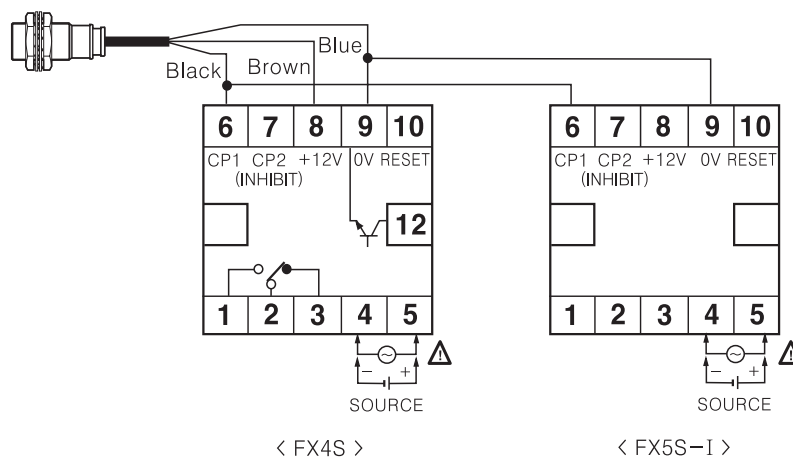

(A) Counter

(B) Timer

(C) Temp. controller

(D) Power controller

(E) Panel meter

(F) Tacho/Speed/Pulse meter

(G) Display unit

(H) Sensor controller

(I) Switching power supply

(J) Proximity sensor

(K) Photo electric sensor

(L) Pressure sensor

(M) Rotary encoder

(N) Stepping motor & Driver & Controller

(O) Graphic panel

(P) Production stoppage models & replacement

# FXS Series

## ■ Description of inner DIP switches

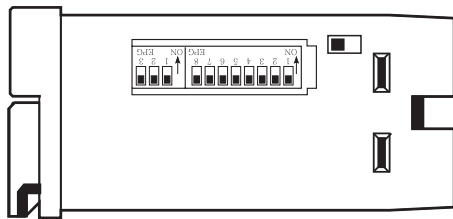

※ Inner selection switch is changed from 10pin to 11pin with upgrade of counting speed.

※ There is no output operation mode in indication type (FX5S-1) and SW2 selection switch.

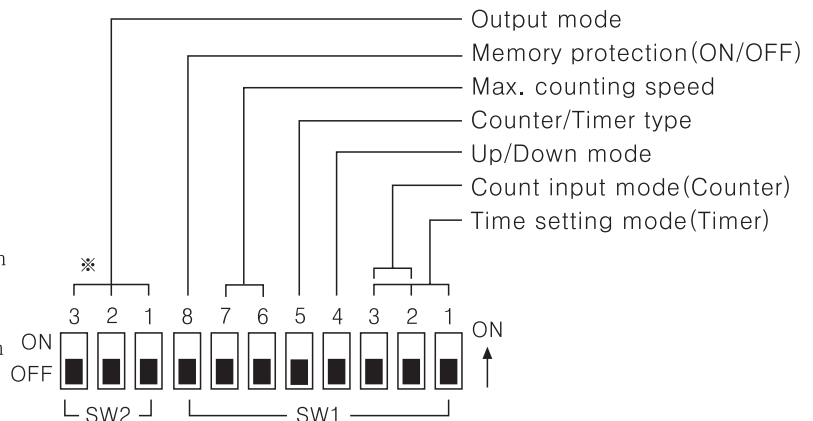

### ● Up/Down mode

SW1	Function
ON <input type="checkbox"/> OFF <input type="checkbox"/>	Down mode
ON <input type="checkbox"/> OFF <input type="checkbox"/>	Up mode

### ● Counter/Timer

SW1	Function
ON <input type="checkbox"/> OFF <input type="checkbox"/>	Counter
ON <input type="checkbox"/> OFF <input type="checkbox"/>	Timer

### ● Memory protection

SW1	Function
ON <input type="checkbox"/> OFF <input type="checkbox"/>	Disable the memory protection
ON <input type="checkbox"/> OFF <input type="checkbox"/>	Enable the memory protection

### ● Max. counting speed

SW1	CP1, CP2
ON <input type="checkbox"/> OFF <input type="checkbox"/>	<b>1cps</b>
ON <input type="checkbox"/> OFF <input type="checkbox"/>	30cps
ON <input type="checkbox"/> OFF <input type="checkbox"/>	2kcps
ON <input type="checkbox"/> OFF <input type="checkbox"/>	<b>5kcps</b>

## ■ Setting function of Decimal point

Display the decimal point.

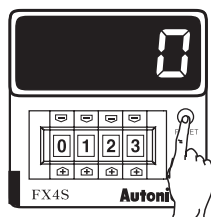

RUN mode

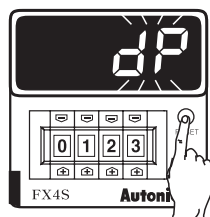

※ When "dP" is flashing, one touch the Reset button.

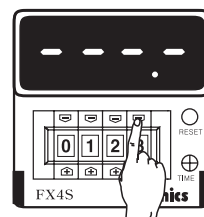

※ Set the position of decimal point using  $\uparrow$ ,  $\downarrow$  buttons of digital switch.

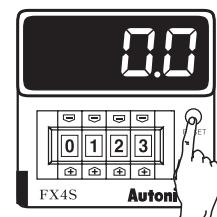

Return to RUN mode

※ It returns to RUN mode if pressing Reset button for over 3sec.

### ● Changing the decimal point

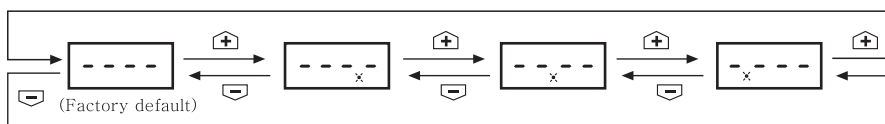













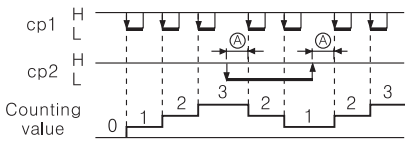
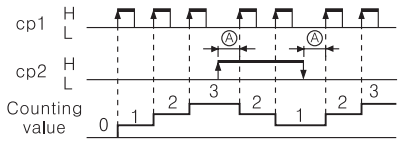

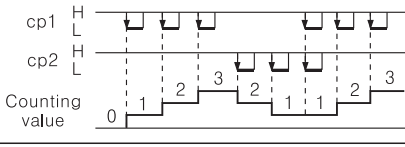
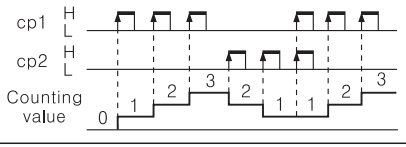

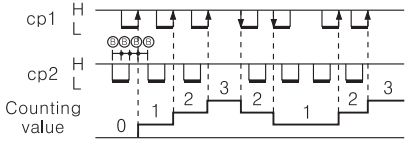
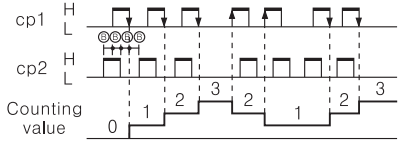

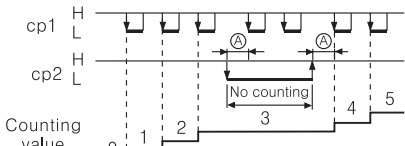
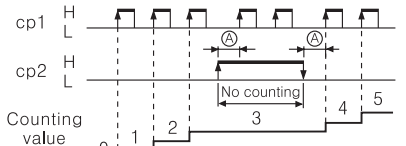
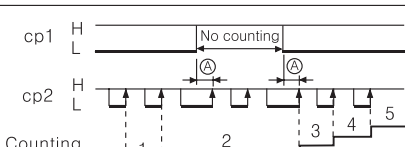
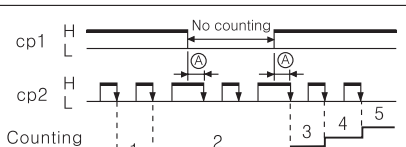

※ It returns to RUN mode if no RESET button or digital switch is applied for 60sec. in decimal point setting status.

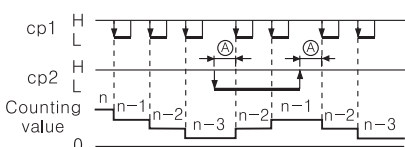
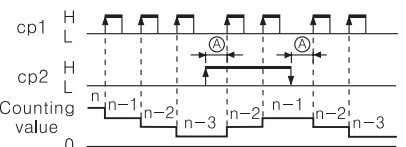
※ The decimal point setting is not existed in indication type.

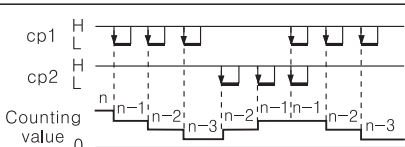
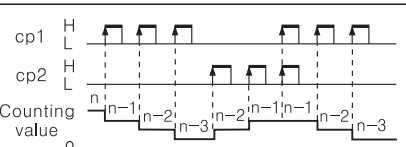
# Up/Down Counter/Timer

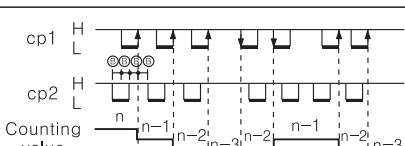
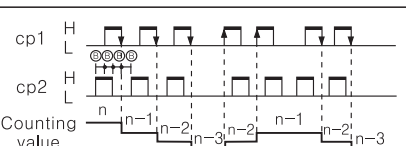
## Input operation mode(Counter)

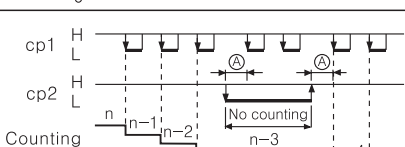
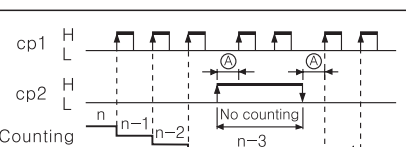
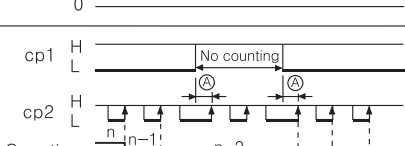
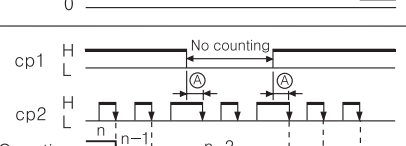
Input mode			No voltage input(NPN)	voltage input(PNP)
<b>Count up mode</b> ON  OFF 	Up/Down-A (Command input)	ON  OFF 		
	Up/Down-B (Individual input)	ON  OFF 		
	Up/Down-C (Phase difference input)	ON  OFF 		
	<b>Up (Count up input)</b> ON  OFF 			
				
<b>Count down mode</b> ON  OFF 	Up/Down-D (Command input)	ON  OFF 		
	Up/Down-E (Individual input)	ON  OFF 		
	Up/Down-F (Phase difference input)	ON  OFF 		
	<b>Down (Count down input)</b> ON  OFF 			
				

\*Ⓐ : Over Min. signal width, Ⓑ : Over 1/2 of Min. signal width.

If the signal width of Ⓐ or Ⓑ is less than Min. signal width, ±1 of count error is occurred.

(A) Counter

(B) Timer

(C) Temp. controller

(D) Power controller

(E) Panel meter

(F) Tacho/Speed/Pulse meter

(G) Display unit

(H) Sensor controller

(I) Switching power supply

(J) Proximity sensor

(K) Photo electric sensor

(L) Pressure sensor

(M) Rotary encoder

(N) Stepping motor & Driver & Controller

(O) Graphic panel

(P) Production stoppage models & replacement

# FXS Series

## Counting operation of indication type(Counter)

### Up input mode

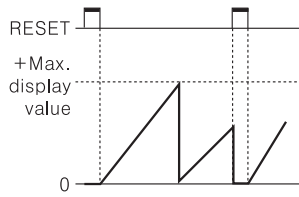

### Down input mode

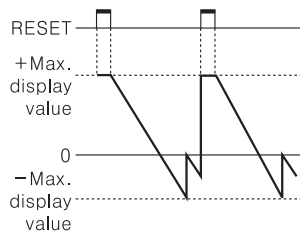

### Up/Down-A, B, C input mode

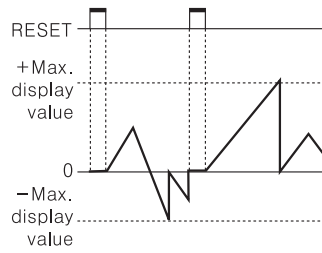

### Up/Down-D, E, F input mode

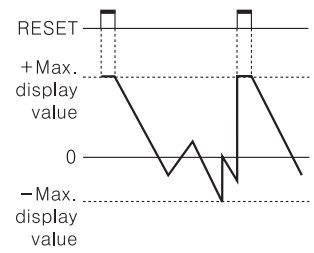

## Time operation of indication type(Timer)

### Up input mode

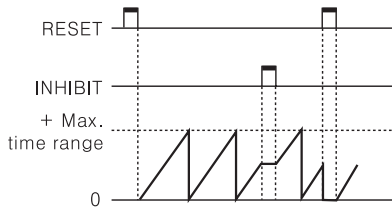

### Down input mode

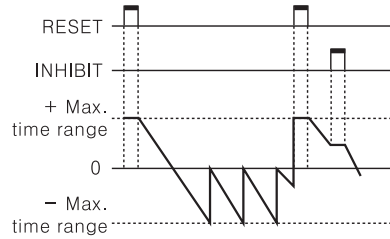

## Time setting mode(Timer)

SW1	4Digit	5Digit
1 2 3 ON [ ] [ ] [ ] OFF [ ] [ ] [ ]	99.99sec	9999.9sec
1 2 3 ON [ ] [ ] [ ] OFF [ ] [ ] [ ]	999.9sec	99999sec
1 2 3 ON [ ] [ ] [ ] OFF [ ] [ ] [ ]	9999sec	9min 59.99sec
1 2 3 ON [ ] [ ] [ ] OFF [ ] [ ] [ ]	99min 59sec	99min 59.9sec
1 2 3 ON [ ] [ ] [ ] OFF [ ] [ ] [ ]	999.9min	9999.9min
1 2 3 ON [ ] [ ] [ ] OFF [ ] [ ] [ ]	99hour 59min	9hour 59min 59sec
1 2 3 ON [ ] [ ] [ ] OFF [ ] [ ] [ ]	999.9hour	999hour 59min
1 2 3 ON [ ] [ ] [ ] OFF [ ] [ ] [ ]	9999hour	9999.9hour

# Up/Down Counter/Timer

## Output operation mode (by internal DIP switch)

■ ← One-shot output (0.05~5sec)

□ ← Self-holding output

Output mode (SW1)	Up mode ON 4 OFF 1		Down mode ON 4 OFF 1		Operation after count up
	Up / Down-A, B, C		Up / Down-D, E, F		
<b>F</b> 8 9 10 ON [ ] [ ] [ ] OFF [ ] [ ] [ ]					The display value continues until reset signal is applied then output is held. • Self-holding output is held until reset signal is applied.
<b>N</b> 8 9 10 ON [ ] [ ] [ ] OFF [ ] [ ] [ ]					The display value and hold output are held until reset signal is applied.
<b>C</b> 8 9 10 ON [ ] [ ] [ ] OFF [ ] [ ] [ ]					The display value returns to reset start status as soon as display value is reached to preset value.
<b>R</b> 8 9 10 ON [ ] [ ] [ ] OFF [ ] [ ] [ ]					The display value is held until output is OFF then returns to reset start status.
<b>K</b> 8 9 10 ON [ ] [ ] [ ] OFF [ ] [ ] [ ]					The display value continues until reset signal is applied.
<b>P</b> 8 9 10 ON [ ] [ ] [ ] OFF [ ] [ ] [ ]					The display value is held during one-shot output time, counting process is returned to reset start status as soon as output is ON.
<b>Q</b> 8 9 10 ON [ ] [ ] [ ] OFF [ ] [ ] [ ]					The display value continues during one-shot output time.
<b>S</b>	<b>Up input</b>		<b>Down input</b>		<ul style="list-style-type: none"> <li>• Up, UP/Down-A, B, C input mode - Output is ON when (Display value) ≥ (Preset value)</li> <li>• Down, UP/Down-D, E, F input mode - Output is ON when (Display value) ≤ (Zero)</li> </ul>
Counter 8 9 10 ON [ ] [ ] [ ] OFF [ ] [ ] [ ]	<b>Up / Down-A, B, C</b>		<b>Up / Down-D, E, F</b>		
<b>S</b> Timer 8 9 10 ON [ ] [ ] [ ] OFF [ ] [ ] [ ]					The output turns ON after the setting time and then turns OFF after the setting time. This operation is repeated sequentially. (Flickering)

(A) Counter

(B) Timer

(C) Temp. controller

(D) Power controller

(E) Panel meter

(F) Tacho/Speed/Pulse meter

(G) Display unit

(H) Sensor controller

(I) Switching power supply

(J) Proximity sensor

(K) Photo electric sensor

(L) Pressure sensor

(M) Rotary encoder

(N) Stepping motor & Driver & Controller

(O) Graphic panel

(P) Production stoppage models & replacement

# FXS Series

## ■ Proper usage

### ◎ Reset function

#### ● Reset

In case of changing the input mode after supplying the power, please take external reset or manual reset. **If reset is not executed, the counter will be working as previous mode.**

#### ● Reset signal width

It is reset perfectly when the reset signal is applied during **max. 20ms** regardless of the contact input & solid-state input.

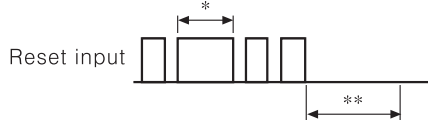

\*In case of a contact reset, it is reset perfectly if the ON time of reset signal is applied during max. 20ms even though a chattering is occurred.

\*\*It can be input the signal of CP1, CP2 after max. 50ms from closing time of reset signal.

### ◎ Sensor power

The power 12VDC which is provided to sensor is built in it. Please use it under Max. 50mADC.

### ◎ Min. signal width of CP1, CP2 input

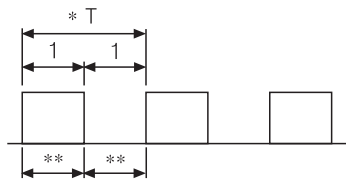

\*Please make duty ratio (ON/OFF) 1:1

\*\* Min. signal width

- 1cps : Min. 500ms
- 30cps : Min. 16.7ms
- 2kcps : Min. 0.25ms
- 5kcps : Min. 0.1ms

### ◎ Max. counting speed

This is a response speed per 1 sec. when the duty ratio (ON:OFF) of input signal is 1:1.

If the duty ratio is not 1:1, the width between ON and OFF should be over min. signal width and the response speed will getting slower against input signal. And one of ON width and OFF width is under min. signal width, this product may not respond.

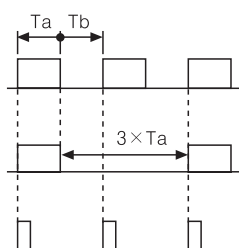

Width of Ta(ON) and Tb(OFF) must be larger than Min. signal width.

Max. counting speed is 1/2 value of catalog spec. when duty ratio is 1:3.

It can not respond because Max. signal width (1a) is small.

### ◎ INHIBIT (When using as Timer)

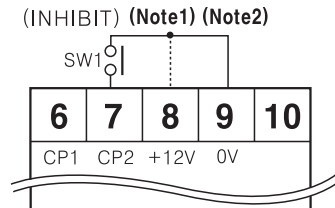

※ (Note1): PNP input  
 (Note2): NPN input

- If SW1 is ON, it becomes INHIBIT. (Time Hold)
- When power is applied, it starts to progress and INHIBIT mode is used to stop the time is under the progress at the moment.
- When SW1 is OFF, timer starts to progress again.

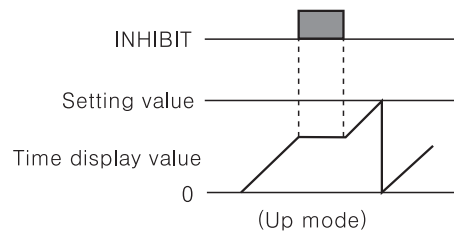

### ◎ Error display

Error signal	Error description	Returning method
Err0	Zero setting status	Change the setting value to non zero status

※ When Error is displayed, the output continues OFF state.  
 ※ There is no Error function in the indication type.

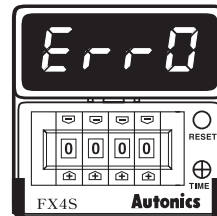

### ◎ Power

The inner circuit voltage starts to rise up for the first 100ms after power on, the input may not work at this time. And also the inner circuit voltage drops down for the last 500ms after power off, the input may not work at this time.

