

M4N Series

DIN W48 × H24mm Small size digital panel meter

■ Features

- Max. display : 1999
- Auto Zero function and Hold function
- 7 Segment LED Display
- Power supply : 5VDC, 12–24VDC

⚠ Please read "Caution for your safety" in operation manual before using.



■ Ordering information

◎DC VOLT METER / DC AMPERE METER

M 4 N - D V - 0 1

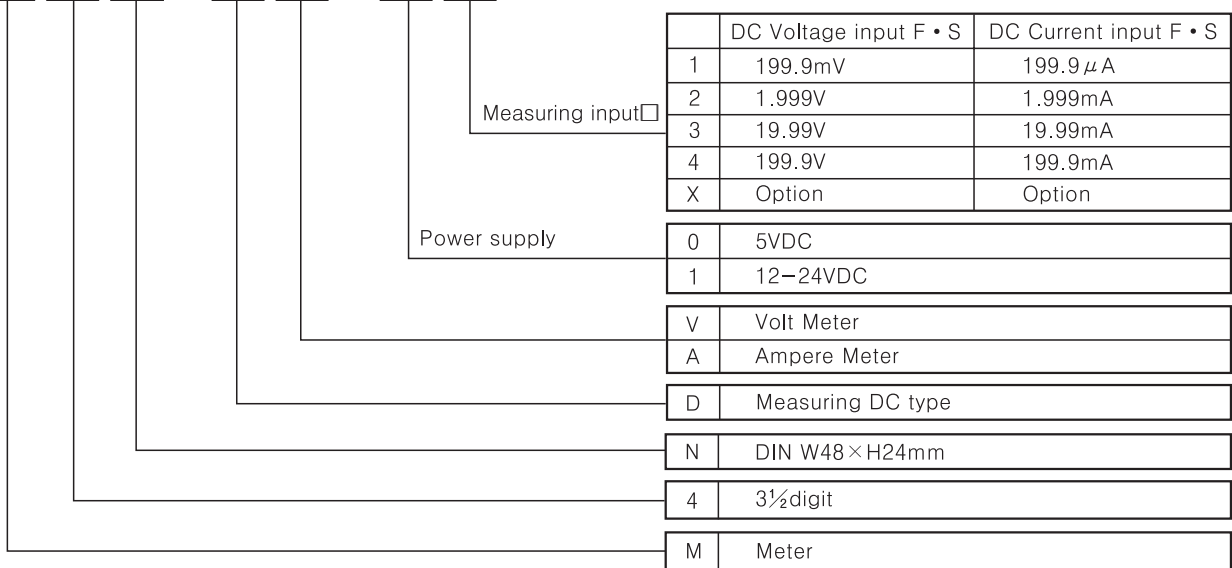

※M4N series cannot measure AC voltage and ampere.

※Measuring range for direct connection is 200VDC, 200mA.

◎DIGITAL SCALING METER

M 4 N - D I - 0 X

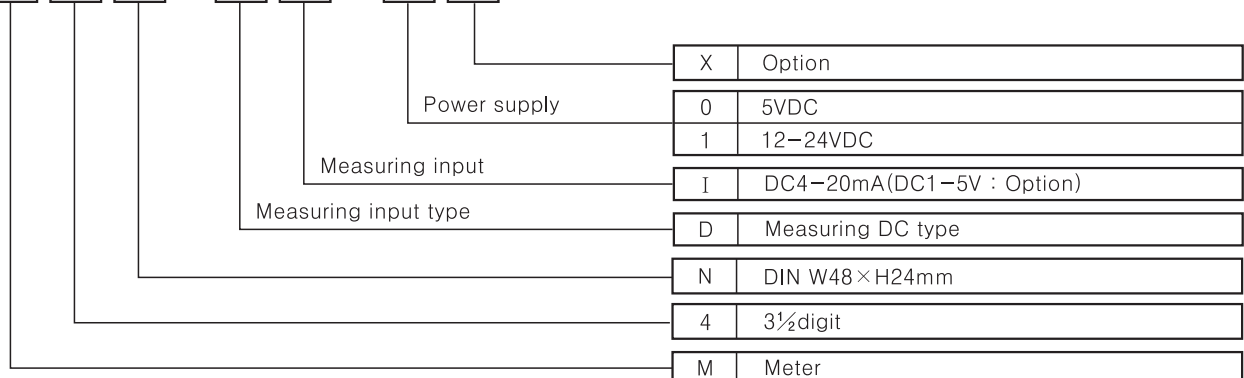

※1–5VDC of measuring input specification is available by option.

It will be a default value if there is no request for order.

Miniature Type Panel Meter

Specifications

Model	M4N-DV- □□	M4N-DA- □□	M4N-DI- □□
Measurement function	DC Voltage	DC Ampere	4-20mADC (1-5VDC Option)
Power supply	5VDC, 12-24VDC		
Allowable voltage range	90~110% of rated voltage		
Power consumption	2W		
Display method	7 Segment Red LED Display (Character height:10mm)		
Display accuracy	F · S ±0.2% rdg ±1digit		
Sampling period	300ms		
A/D switching method	Dual integral method		
Response time	Approx. 2sec.(0 ~ Max.)		
Max. allowable input	150% of measurement input		
Sampling time	2.5 times/sec		
Insulation resistance	Min. 100MΩ (at 500VDC)		
Dielectric strength	2000VAC 50/60Hz for 1 minute		
Noise strength	±100V the square wave noise (pulse width:1μs) by the noise simulator		
Vibration	Mechanical	0.75mm amplitude at frequency of 10 ~ 55Hz in each of X, Y, Z directions for 1hour	
	Malfunction	0.5mm amplitude at frequency of 10 ~ 55Hz in each of X, Y, Z directions for 10minutes	
Shock	Mechanical	300m/s ² (30G) in X, Y, Z direction	
	Malfunction	100m/s ² (10G) in X, Y, Z direction□	
Ambient temperature	-10 ~ +50℃ (at non-freezing status)		
Storage temperature	-20 ~ +60℃ (at non-freezing status)		
Ambient humidity	35 ~ 85%RH		
Unit weight	Approx. 42g		

(A) Counter

(B) Timer

(C) Temp. controller

(D) Power controller

(E) Panel meter

(F) Tacho/Speed/Pulse meter

(G) Display unit

(H) Sensor controller

(I) Switching power supply

(J) Proximity sensor

(K) Photo electric sensor

(L) Pressure sensor

(M) Rotary encoder

(N) Stepping motor & Driver & Controller

(O) Graphic panel

(P) Production stoppage models & replacement

Connection

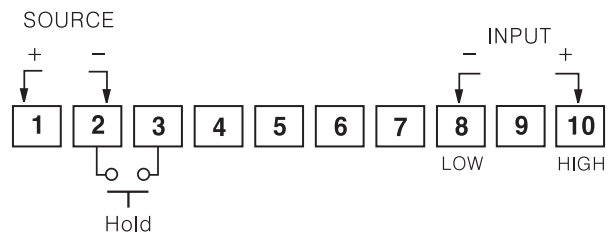
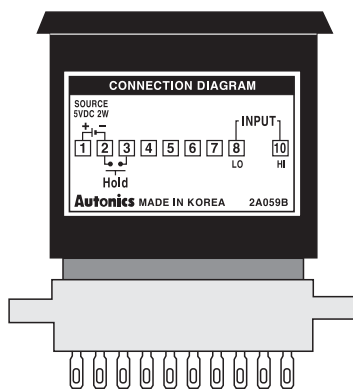

※Socket pin 9, NC terminal, is not connected to internal circuit.

M4N Series

Dimensions

Bracket

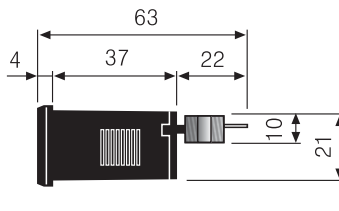
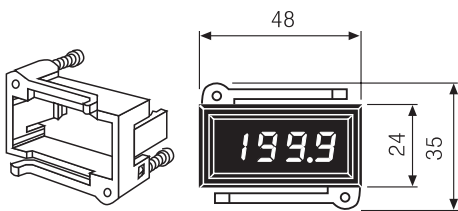

Panel cut-out

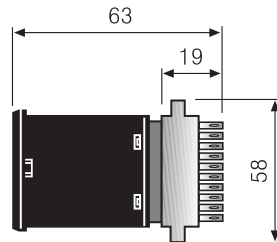
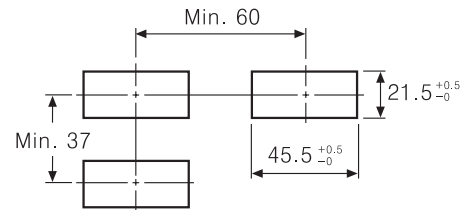

(Unit:mm)

Connections

DC voltmeter connection

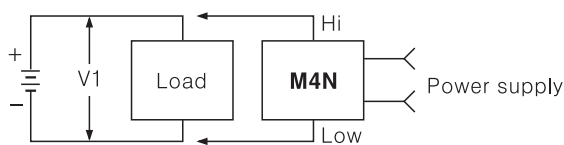

(Fig. 1) Measuring input (V1) is under 200VDC

DC Amperemeter connection

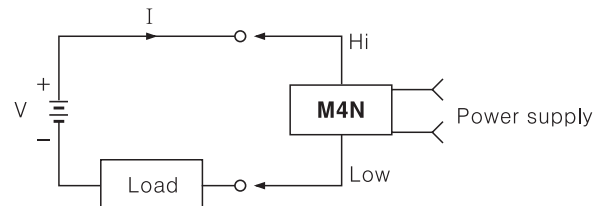

(Fig. 3) Measuring current is under 200mADC

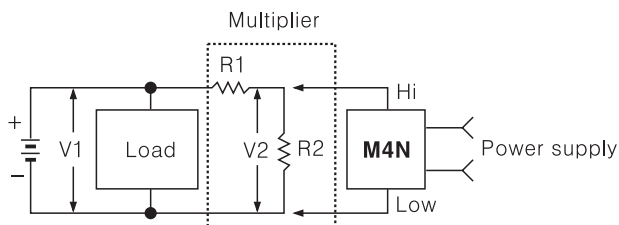

(Fig. 2) Measuring input(V1) is under 200VDC

※When the measuring voltage is over 200VDC, please select R1 and R2 in order to make V2 less than Max. measuring voltage using multiplier.

$$V2 = \frac{R2}{R1+R2} \times V1 \quad R1 > R2$$

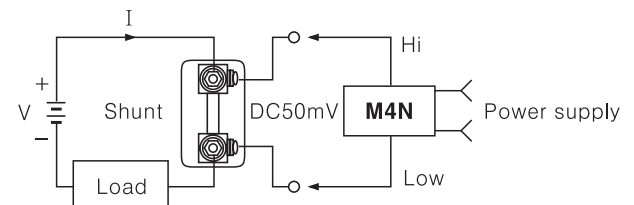

(Fig. 4) Measuring current is over 200mADC

※When the current is larger than 200mADC, please use shunt.

※Second section of shunt is 50mVDC.

Scaling meter connection

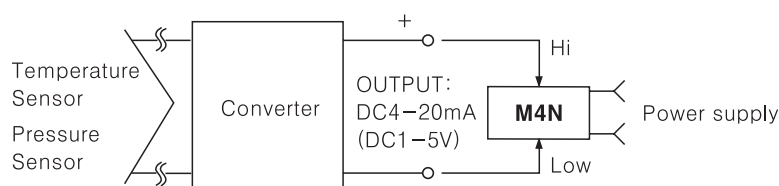

※1-5VDC output of converter is optional.

Miniature Type Panel Meter

■ Proper usage

◎ Caution for selecting and using products

- Please notice the product customized by requirement cannot be replaced.
- When supplying the power, it may display arbitrary number, because measuring input terminal is opened. If connecting Low terminal of measuring input to GND, it displays "000".
- If it indicates 1 or -1 during input signal is ON, please turn OFF the power and check the connection condition, because the input signal is too low or high.
- When measuring voltage is higher than 200VDC, please divide the voltage with multiplying resistance to make lower than 200VDC.
(Refer to the connection method of DC voltmeter in the application of connections)

Ex) Measuring 1000VDC

As the above connection figure of DC voltmeter, select the R1 value to make 200VDC on R2.

(Generally R1 value will be higher than R2 value.)

Order the D.P.M indicating 1000V for 300VDC.

- Select another item or use shunt for over than DC200mA of measured value.
(See the connection method of DC current for the application of using shunt.)

Ex) In case of measuring 20ADC

Use the shunt used for 20ADC/DC50mV and the specification should be ordered as M4N-DV-X DC50mV/19.99.

※ Our company does not sell a shunt.

Please connect to our agency for buying the item.

- M4N series is produced for 5VDC and 12-24VDC. Therefore, before you order the item please check the model again.
- The specification of measurement input, which is indicated in model ordering, is a standard specification, 1:1 of measurement input and processing value. The optional specifications are available with your order.

* The application of M4N-DV/M4N-DA

M4N - DV - 0X DC10V / 100.0

M4N - DA - 0X DC50mA / 199.9

* The application of M4N-DI

M4N - DI - 0X DC4-20mA / 100.0

- ote) If measurement input is 1-5VDC, please indicate it. Otherwise, it will be produced with DC4-20mA.

● Indicating method of unit

M4N is not indicated a unit on the product, therefore please indicate it in panel.

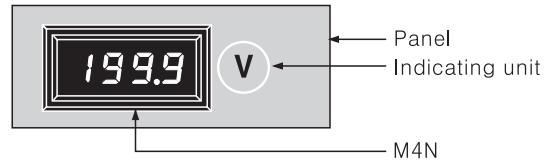

● Display of decimal point

The displaying decimal point is set in the product by your order.

(The prior products display the decimal point by using jump line in external connector like as connection figures.)

After purchasing the product, do not change the decimal point. If you need to change it, please connect to us or distributor.

◎ Caution for connecting M4N

- In case of using both voltmeter and amperemeter **Because the connection of measurement input terminal and power terminal is not insulated**, when you use voltmeter and amperemeter by connecting one set, please provide individual power. In case of using same power, it may damage the product.

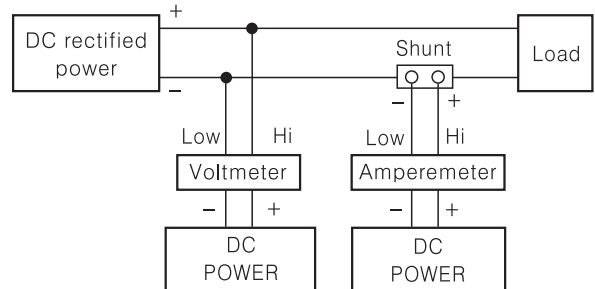

- It is available using several voltmeters with providing one DC power. However, the potential difference between - of measurement input and - of power may cause an error.

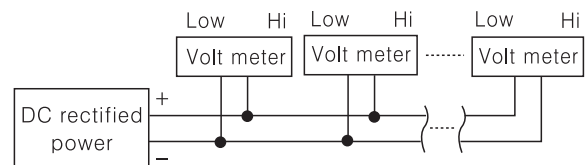

※ Amperemeter cannot be used with above connection. Please provide power separately.

- Make sure to check the polarity of provided power before turn ON the power.
(If the polarity is connected reversely, internal circuit could be damaged.)
- Please check if the pin numbers are changed after connecting

(A)	Counter
(B)	Timer
(C)	Temp. controller
(D)	Power controller
(E)	Panel meter
(F)	Tacho/ Speed/ Pulse meter
(G)	Display unit
(H)	Sensor controller
(I)	Switching power supply
(J)	Proximity sensor
(K)	Photo electric sensor
(L)	Pressure sensor
(M)	Rotary encoder
(N)	Stepping motor & Driver & Controller
(O)	Graphic panel
(P)	Production stoppage models & replacement