

PSA / PSB Series

Small size, High accuracy pressure control digital pressure sensor

Features

- High accuracy digital pressure sensor
- High brightness red LED(LED height:9.5mm)
- High resolution : 1/1000
- Convertible pressure unit
Vacuum pressure, Compound pressure :
kPa, kgf/cm², bar, psi, mmHg, mmH₂O, inHg
Standard pressure : kPa, kgf/cm², bar, psi
- Various output modes : Hysteresis mode, Automatic sensitivity setting mode, Individual 2 output mode, Window comparative output mode
- Chattering prevention for output
(Selectable response time : 2.5, 5, 100, 500ms)
- Analog output(1-5VDC)
- Built-in overcurrent protection circuit, Reverse power polarity protection circuit
- Zero point adjustment function
- Peak and Bottom hold display

⚠ Please read "Caution for your safety" in operation manual before using.



PSA Type



PSB Type



PSB Connector Type

Ordering information

PS A - V 01 C P - Rc1/8

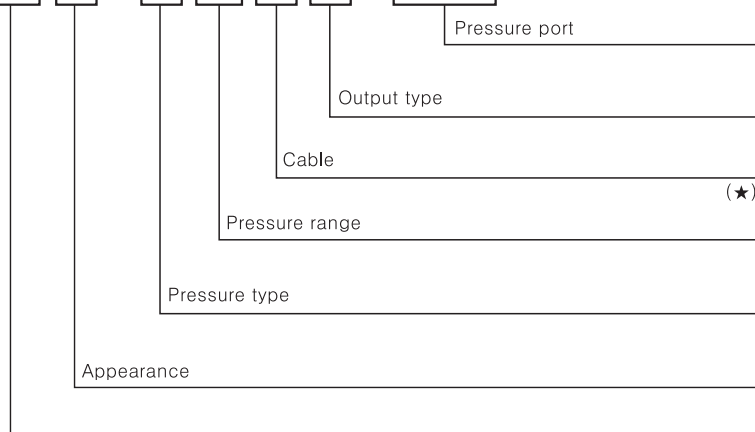

Rc1/8	Standard(PSA Type)
NPT1/8	Option(PSA Type)
M5	Standard(PSB Type)
	NPN open collector output
P	PNP open collector output
	Standard(Cable integral type)
(★) C	Connector type
01	100kPa
1	1MPa
	Standard pressure type
V	Vacuum pressure type
C	Compound pressure type
A	Regular square(30mm×30mm)
B	Rectangular(10.2mm×54mm)
PS	Pressure Sensor

※ (★) is only applied to PSB Series.

Pressure and Max. pressure display range

Type	kPa	kgf/cm ²	bar	psi	mmHg	inHg	mmH ₂ O
Vacuum pressure	0 ~ -101.3 (5.0 ~ -101.3)	0 ~ -1.034 (0.051 ~ -1.034)	0 ~ -1.013 (0.05 ~ -1.013)	0 ~ -14.70 (0.74 ~ -14.70)	0 ~ -760 (38 ~ -760)	0 ~ -29.9 (1.5 ~ -29.9)	0 ~ -103.4 (5.2 ~ -103.4)
Standard pressure	0 ~ 100.0 (-5.0 ~ 110.0)	0 ~ 1.020 (-0.051 ~ 1.122)	0 ~ 1.020 (-0.050 ~ 1.100)	0 ~ 14.50 (-0.726 ~ 15.96)	—	—	—
	0 ~ 1000 (-50 ~ 1013)	0 ~ 10.20 (-0.51 ~ 11.22)	0 ~ 10.00 (-0.50 ~ 11.00)	0 ~ 145.0 (-7.2 ~ 159.6)	—	—	—
Compound pressure	100.0 ~ -100.0 (110.0 ~ -101.3)	1.020 ~ -1.020 (1.122 ~ -1.034)	1.020 ~ -1.020 (1.100 ~ -1.013)	14.50 ~ -14.50 (15.96 ~ -14.70)	750 ~ -750 (824 ~ -760)	29.5 ~ -29.5 (32.6 ~ -29.9)	102.1 ~ -103.4 (112.3 ~ -103.4)

※ () is Max. pressure display range.

※ When using a unit mmH₂O, please multiply display value by 100.

Pressure conversion chart

from \ to	Pa	kPa	MPa	kgf/cm ²	mmHg	mmH ₂ O	psi	bar	inHg
1kPa	1000.000	1	0.001000	0.010197	7.500616	101.9689	0.145038	0.010000	0.2953
1kgf/cm ²	98069.10	98.06910	0.098069	1	735.5787	10000.20	14.22334	0.980691	28.95979
1mmHg	133.3220	0.133322	0.000133	0.001359	1	13.5954	0.019336	0.001333	0.039370
1mmH ₂ O	9.80665	0.00980	—	0.000099	0.0735578	1	0.00142	0.000098	0.002895
1psi	6894.939	6.89493	0.00689	0.070307	51.71630	703.07	1	0.068947	2.036074
1Pa	100000.0	100.0000	0.100000	1.019689	750.062	10196.89	14.50339	1	29.52998
1inHg	3386.388	3.386388	0.003386	0.034530	25.40000	345.3240	0.491141	0.033863	1

Ex) In case of calculating 760mmHg as kPa :

According to above chart, 1mmHg is 0.133322kPa, therefore 760mmHg will be 760×0.133322kPa=101.32472kPa.

Pressure Sensor

Specifications

Pressure type		Gauge pressure			
		Vacuum pressure type	Standard pressure type		Compound pressure type
Model	NPN output	PSA-V01 PSB-V01 PSB-V01C	PSA-01 PSB-01 PSB-01C	PSA-1 PSB-1 PSB-1C	PSA-C01 PSB-C01 PSB-C01C
	PNP output	PSA-V01P PSB-V01P PSB-V01CP	PSA-01P PSB-01P PSB-01CP	PSA-1P PSB-1P PSB-1CP	PSA-C01P PSB-C01P PSB-C01CP
Rated pressure range		0.0~101.3kPa	0~100.0kPa	0~1,000kPa	-100.0~100.0kPa
Display and set pressure range		5.0~-101.3kPa	-5.0~110.0kPa	-50~1,100kPa	-101.2~110.0kPa
Max. pressure range		2 times of rated pressure		1.5 times of rated pressure	2 times of rated pressure
Applicable fluid		Air, Non-corrosive gas			
Power supply		12V~24VDC ±10% (Ripple P-P:Max. 10%)			
Current consumption		Max. 50mA			
Control output		<ul style="list-style-type: none"> NPN open collector output ⇒ Load current : Max. 100mA, Load voltage : Max. 30VDC, Residual voltage : Max. 1V PNP open collector output ⇒ Max. sink current : Max. 100mA, Residual voltage : Max. 2V 			
Hysteresis		(*1) 1digit (2digit/psi) fixed		2digits fixed	
Repeat error		±0.2% F.S. ±1digit		±0.2% F.S. ±2digits	
Response time		Selectable 2.5ms, 5ms, 100ms, 500ms			
Short circuit protection		Includes			
Analog output		<ul style="list-style-type: none"> Output voltage : 1~5VDC ±2% F.S. Zero point: Within 1VDC ±2% F.S. Span: Within 4VDC ±2% F.S. Linear : Within ±2% F.S. Resolution : Approx. 1/200 Output impedance : 1kΩ 			
Display method		3½ digit LED 7Segment			
Min. display interval		1digit (2digit/psi)		2digits	
Pressure unit		kPa, kgf/cm ² , bar, psi, mmHg, mmH ₂ O, inHg	kPa, kgf/cm ² , bar, psi		kPa, kgf/cm ² , bar, psi, mmHg, mmH ₂ O, inHg
Characteristic of control output and displayed temp.		(*2) Max. ±1% F.S.		Max. ±2% F.S.	
Analog output temperature characteristic		(*2) Max. ±2% F.S.			
Environment	Ambient temperature	-10°C ~ +50°C (at non-freezing status)			
	Storage temperature	-20°C ~ +60°C (at non-freezing status)			
	Ambient humidity	35 ~ 85%RH			
	Storage humidity	35 ~ 85%RH			
	Vibration	1.5mm amplitude at frequency of 10 ~ 55Hz in each of X, Y, Z directions for 2 hours			
Material		<ul style="list-style-type: none"> PSA ⇒ Front case : PC, Rear case : PC (Insert glass), Pressure port : die-cast (Zn) PSB ⇒ Case, Pressure port : PA, PSB-C ⇒ Case, Pressure port, Cover : IXEF 			
Protection		IP40 (IEC standard)			
Cable		∅ 4mm, 5P, Length : 2m (Connector type:3m)			
Approval		CE			
Unit weight		PSA : Approx. 120g, PSB : Approx. 70g, PSB-C : Approx. 80g			

※ F.S. (Full Scale) : Specified pressure range.

※ (*1) The Hysteresis is changeable in output operation of F-1 mode.

※ (*2) It is based on the pressure of 25°C within 0~50°C.

● Analog output voltage-Pressure characteristic

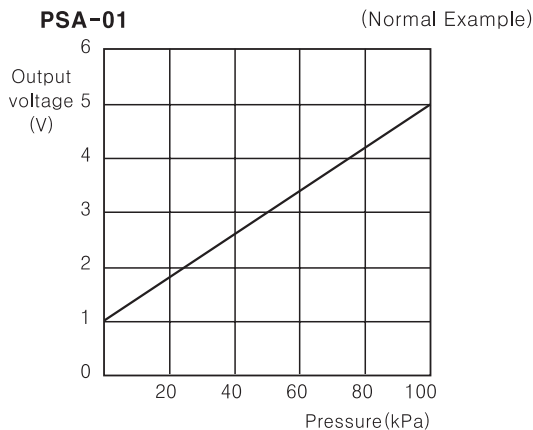

● Analog output voltage linear characteristic

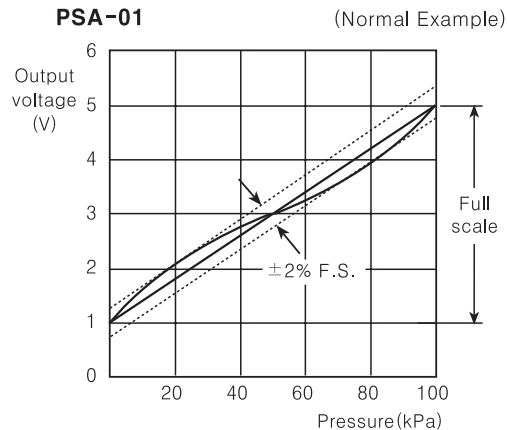

- (A) Counter
- (B) Timer
- (C) Temp. controller
- (D) Power controller
- (E) Panel meter
- (F) Tacho/Speed/Pulse meter
- (G) Display unit
- (H) Sensor controller
- (I) Switching power supply
- (J) Proximity sensor
- (K) Photo electric sensor
- (L) Pressure sensor
- (M) Rotary encoder
- (N) Stepping motor & Driver & Controller
- (O) Graphic panel
- (P) Production stoppage models & replacement

PSA / PSB Series

Dimensions

(Unit:mm)

PSA

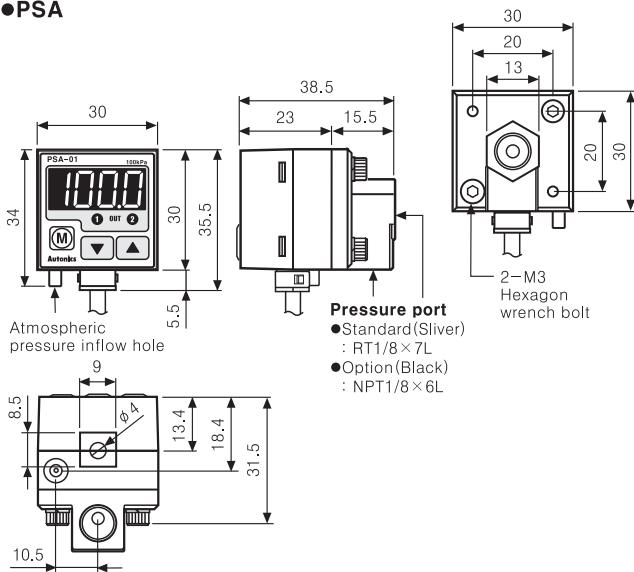

PSB

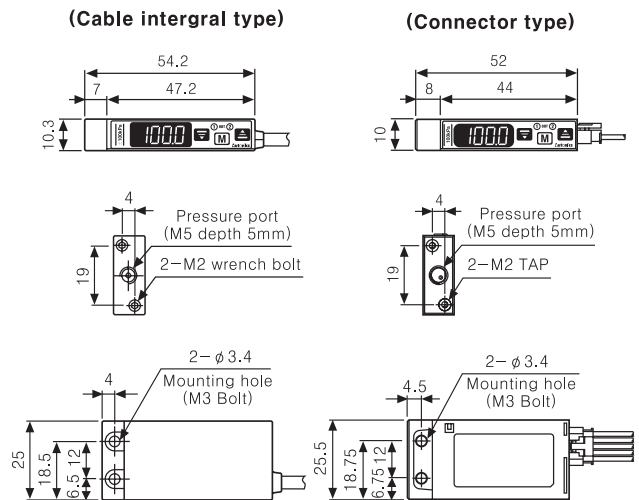

Fixing bracket A (PSA type)

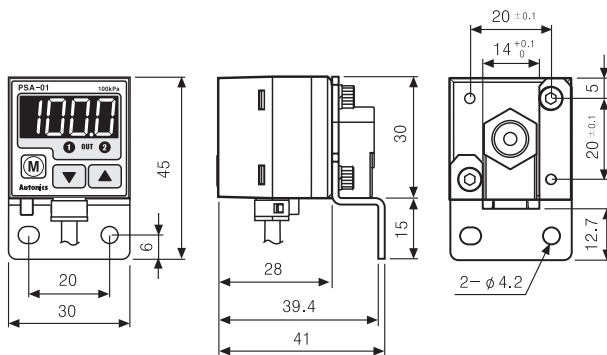

Fixing bracket B for mounting (PSA type)

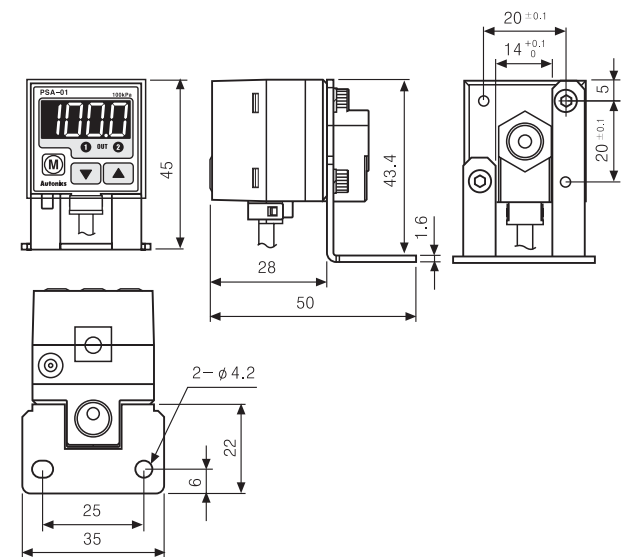

Bracket for mounting (PSA type)

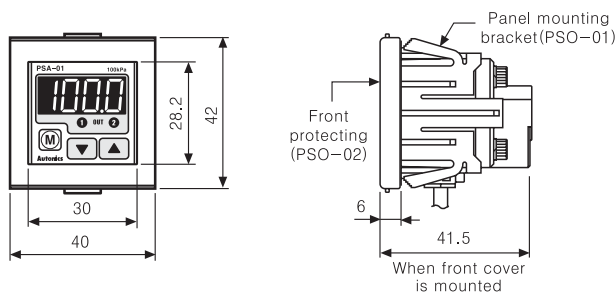

Panel cut-out

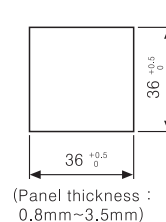

Accessory (Option)

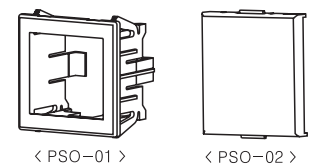

Bracket-A

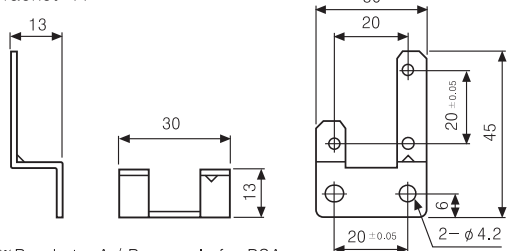

Bracket-B

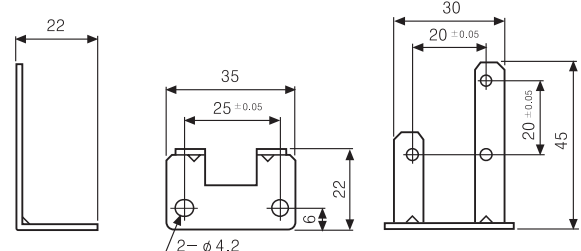

※Bracket-A / B are only for PSA.

Pressure Sensor

Control output diagram(PSA/PSB)

●NPN open collector output

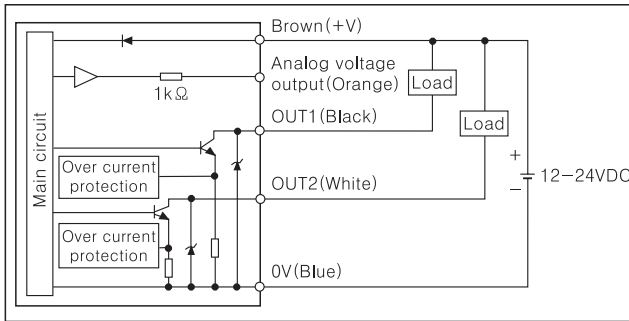

●PNP open collector output

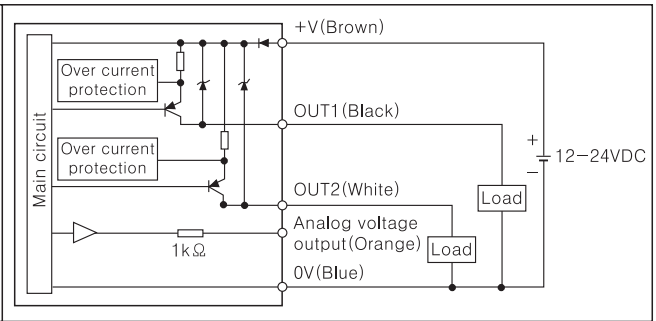

- ※ There is no short-circuit protection in analog voltage output. Do not connect this output to power source or capacitive load directly.
- ※ Please observe input impedance of connected equipment when use analog voltage output. And be sure to check voltage drop caused by resistance of extended wire.

Front panel identification

(PSA Type)

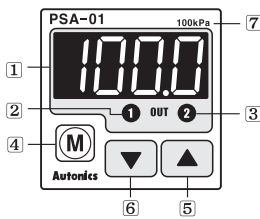

(PSB Type)

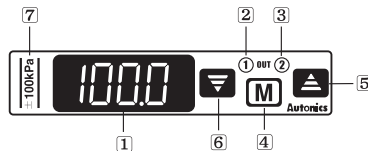

- 3 1/2 LED display (Red)** : Display sensing pressure, every setting value and display error
- 1 output indicator (Red)** : Output 1 is ON, LED will be ON
- 2 output indicator (PSA:Red, PSB:Green)** : Output 2 is ON, LED will be ON

- 4 Mode key** : Parameter setting mode or preset setting mode, save setting value
- 5 Up key** : Set the setting value to lower step in preset setting or pressure unit, output mode, response time, analog output scale, key lock, peak hold value, bottom hold value display in parameter setting
- 6 Down key** : Set setting value to upper step in preset setting or pressure unit, output mode, response time, analog output scale, key lock, peak hold, bottom hold display in parameter setting
- 7 Range of rating pressure** : It is possible to change the pressure unit in PSA series. Please use different unit as label for your application.

Setting(PSA/PSB)

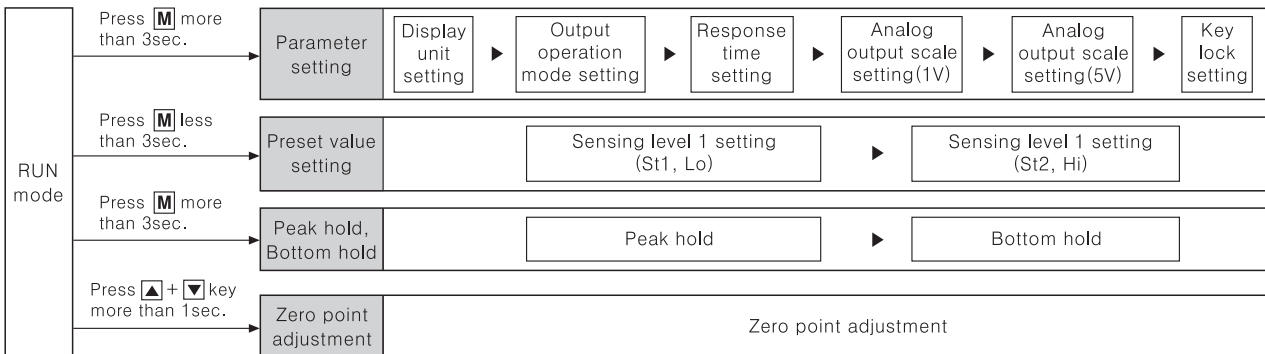

Operations(PSA/PSB)

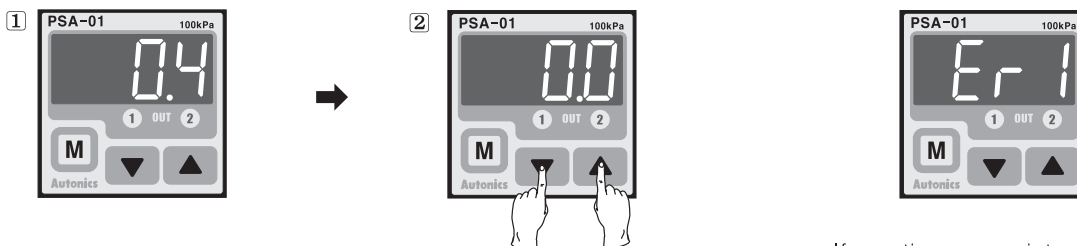

- In state of atmospheric pressure during RUN mode, press **M** key and **▲** key at the same time for over 1sec.
- When the zero point adjustment is completed, it will display **0.0** and return to RUN mode automatically.

※ Please execute Zero point adjustment regularly.

If executing zero point adjustment when external pressure has been applied, **Er 1** will be flashing. Please execute Zero point again in state of atmospheric pressure.

(A) Counter

(B) Timer

(C) Temp. controller

(D) Power controller

(E) Panel meter

(F) Tacho/Speed/Pulse meter

(G) Display unit

(H) Sensor controller

(I) Switching power supply

(J) Proximity sensor

(K) Photo electric sensor

(L) Pressure sensor

(M) Rotary encoder

(N) Stepping motor & Driver & Controller

(O) Graphic panel

(P) Production stoppage models & replacement

PSA / PSB Series

Setting parameter(PSA/PSB)

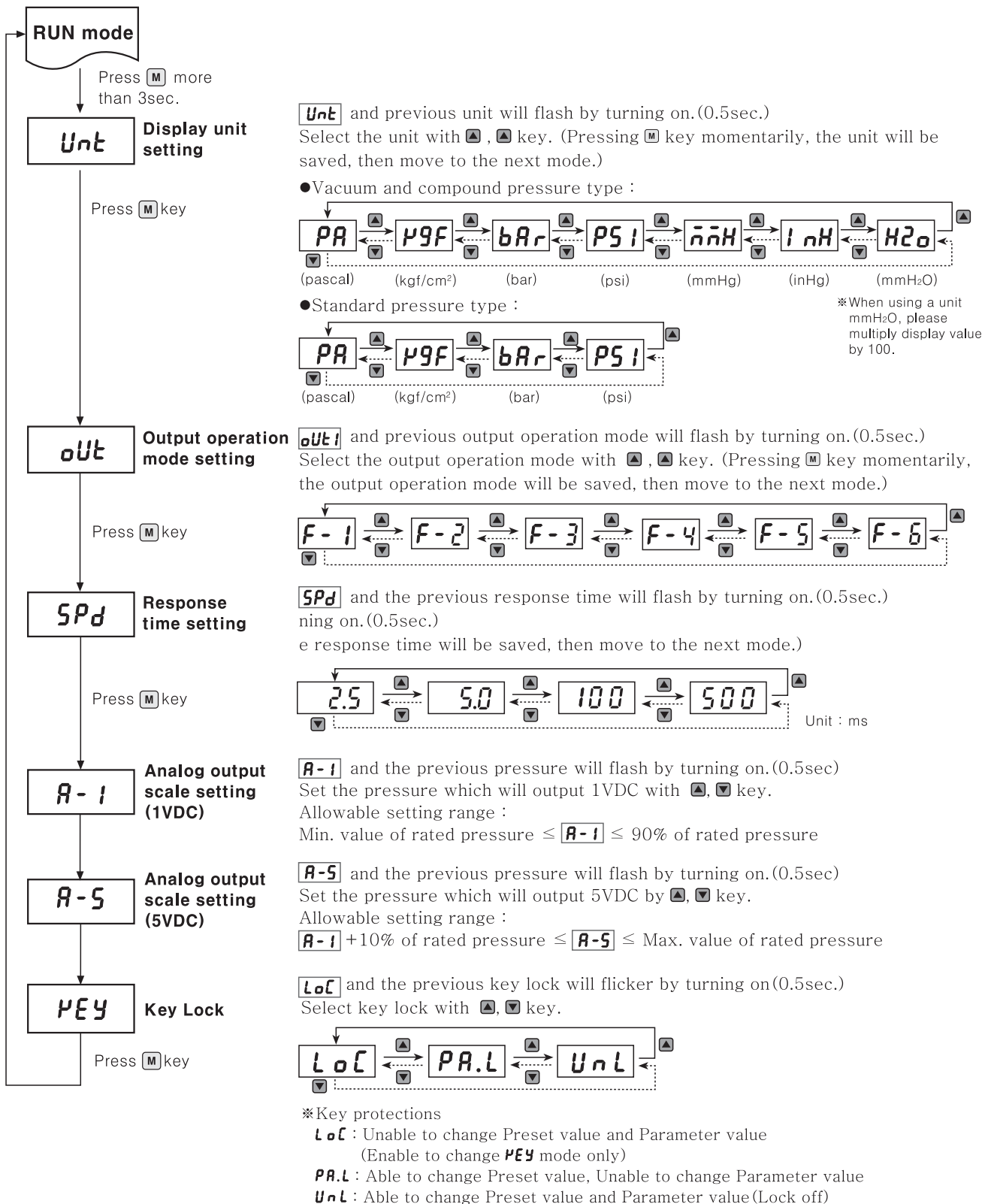

※When advance to Parameter setting mode and preset setting mode, it displays "Setting item" and "Previous setting value" by 0.5 sec. turn. This display will stop by pressing ▼ or ▲ key (Display setting value), if any key is untouched for over 1 sec., it will display old value by 0.5sec. turn again.

※When M Key is pressed for 3sec. during setting, it will return to RUN mode with memorizing on EEPROM. However, when there is any key is untouched for 60sec., it turns to RUN mode with keeping the previous setting value not current setting value.

※There is memory protection by EEPROM, but life cycle of EEPROM is 100,000 times.

■ Preset value setting(PSA/PSB)

● Hysteresis mode(F-1) and independent(F-3, F-4, F-5) 2 output mode

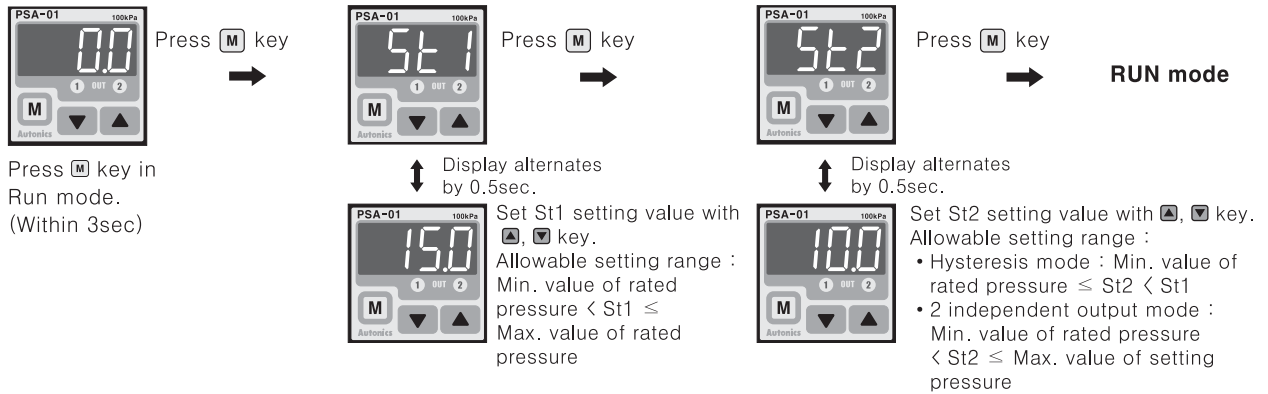

● Automatic sensitivity setting mode(F-2)

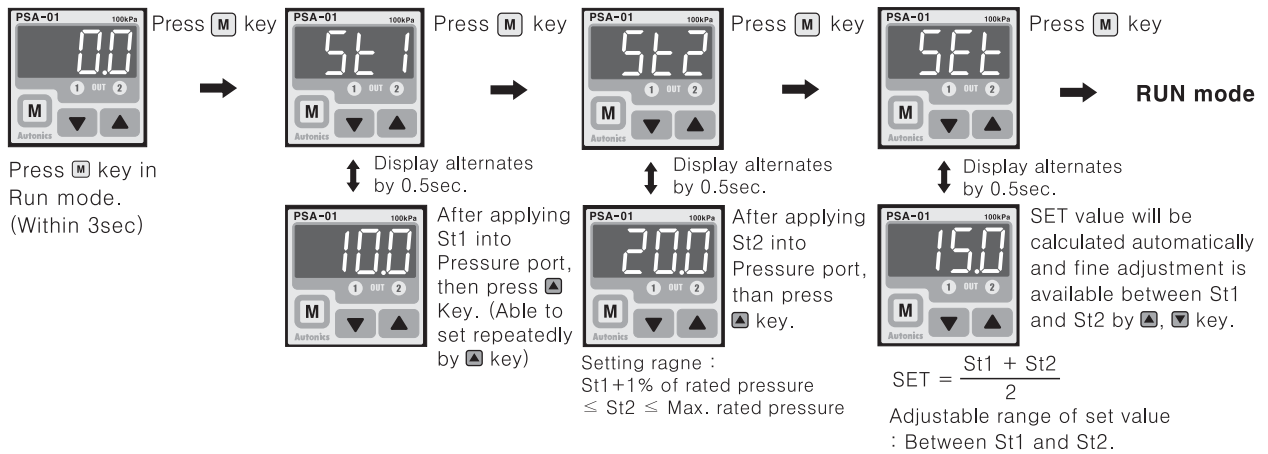

● Window mode(F-6)

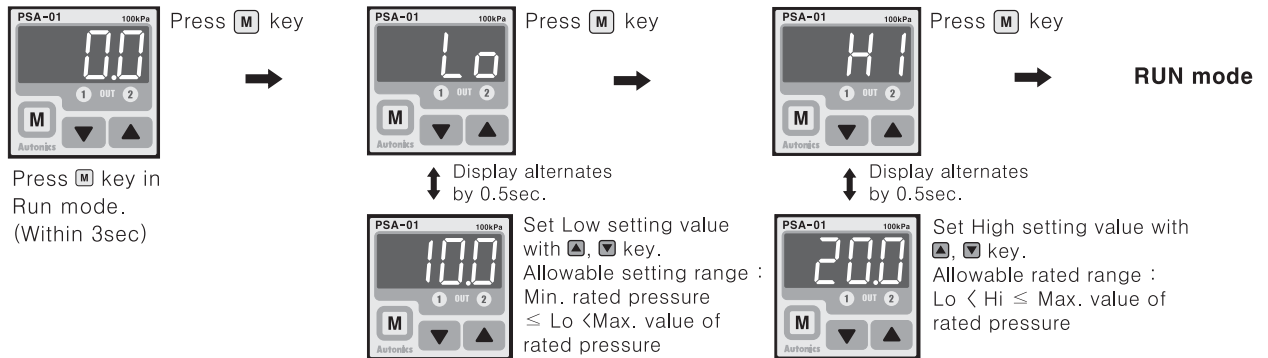

- If no key is touched for 60sec., it will return to RUN mode. [Automatic sensitivity setting mode(F-2) is exception]
- When changing the display unit, preset value will be calculated according to the display unit.
- Whenever key touched one time, it is increased(decreased) as 1 digit(2 digits for psi unit and compound pressure) but it will be continuously increasing(decreasing) by pressing **▲**, **▼** key constantly.

■ Peak Hold and Bottom Hold

1. Press **▲** for more than 3sec. in RUN mode.
2. **PE.H** and memorized max. pressure(Negative type is for max. vacuum pressure) will flash by turning on (0.5sec.) then display Peak hold value.
3. **bo.H** and memorized min. pressure(Negative type is for min. vacuum pressure) will flash by turning on (0.5sec.) then display Bottom hold value.
4. If pressing **▲** key one time shortly, memorized Peak hold and Bottom hold value will be removed then return to RUN mode.

※ When the Peak hold and Bottom hold value is over the max. display pressure value, it displays **HHH**. On the opposite, it displays **LLL**. Please remove Peak hold and Bottom hold value by using **▲** key.

(A)	Counter
(B)	Timer
(C)	Temp. controller
(D)	Power controller
(E)	Panel meter
(F)	Tacho/Speed/Pulse meter
(G)	Display unit
(H)	Sensor controller
(I)	Switching power supply
(J)	Proximity sensor
(K)	Photo electric sensor
(L)	Pressure sensor
(M)	Rotary encoder
(N)	Stepping motor & Driver & Controller
(O)	Graphic panel
(P)	Production stoppage models & replacement

PSA / PSB Series

Output operation mode(PSA/PSB)

1. Hysteresis mode(F-1)

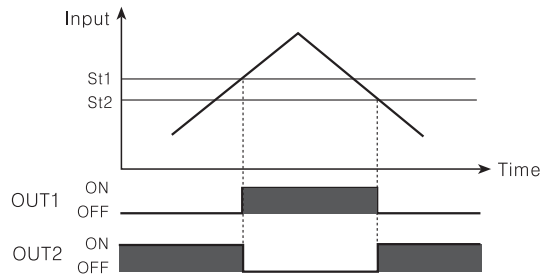

※It can be set for pressure sensing level(St1) and sensing difference(St2).

※St1 setting range : Min. value of specified pressure \leq St1 \leq Max. value of specified pressure

St2 setting range : Min. value of specified pressure \leq St2 \leq St1

- OUT 1 : When applying pressure is larger than St1, it will be ON.
- OUT 2 : When applying pressure is lower than St2, it will be ON.

2. Automatic sensitivity setting mode(F-2)

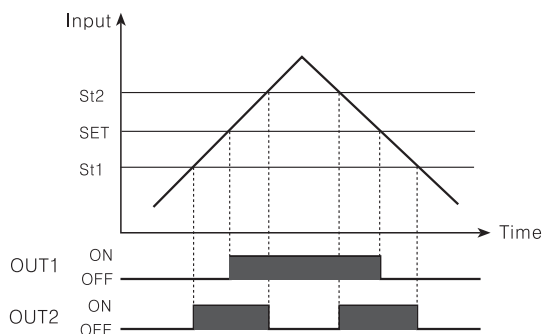

※This function is to set pressure sensing level to the proper position automatically, it is set by received pressure from two position(St1, St2).

※The sensing hysteresis fixed to 1 digit(2 digits for psi unit and compound type)

※Sensing(SET) value will be calculated as below.

$$\text{SET setting value} = \frac{(\text{St1 setting value} + \text{St2 setting value})}{2}$$

- OUT 1 : When applying pressure is larger than SET value, it will be ON.
- OUT 2 : When applying pressure is between St1 and St2, it will be ON.

Note1)If it is not enough for difference of sensing level between St1 and St2, [Er3] will be displayed.

Please set again after applying enough pressure.

Note2)St2 setting range : St1+1% of rated pressure \leq St2 \leq Max. value of specified pressure

Note3)If fine adjustment for sensing level is required, adjust sensing level by Δ , \square key.

(Adjustment range : Between St1 and St2)

3. Independent 2 output mode(F-3, F-4, F-5)

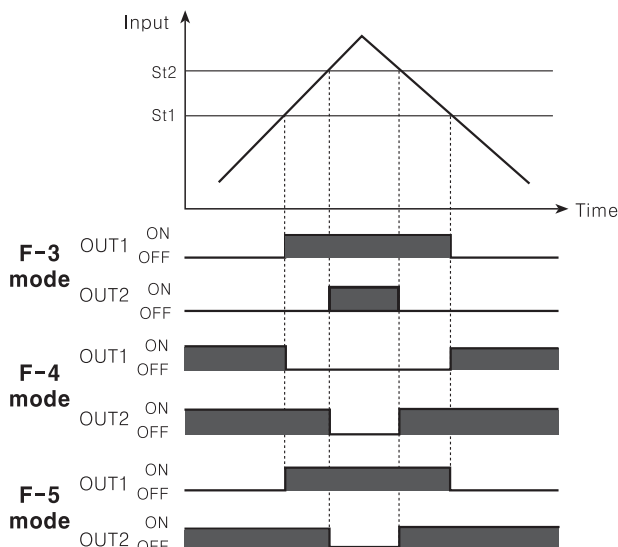

※St1 and St2 can be set independently within specified pressure range. One is for control, the other is for alarm or optional control.

※The sensing hysteresis fixed to 1 digit(2 digits for psi unit and compound type)

※St1 setting range : Min. value of specified pressure \leq St1 \leq Max. value of specified pressure

St2 setting range : Min. value of specified pressure \leq St2 \leq Max. value of specified pressure

- Independent 2 output mode(F-3)
 - OUT 1 : It will be ON, when it is beyond St1.
 - OUT 2 : It will be ON, when it is beyond St2.
- Independent 2 opposite mode(F-4)
 - OUT 1 : It will be OFF when it is beyond St1.
 - OUT 2 : It will be OFF, when it is beyond St2.
- Independent 2 cross mode(F-5)
 - OUT 1 : It will be OFF when it is under St1.
 - OUT 2 : It will be ON, when it is under St2.

4. Window mode(F-6)

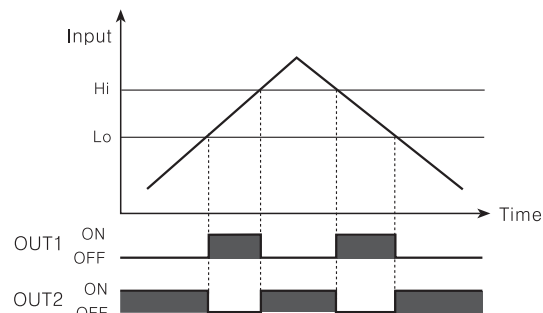

※It is able to set Lo/Hi-limit value of pressure sensing level in this mode.

※The sensing hysteresis fixed to 1 digit(2 digits for psi unit and compound type)

※Lo setting range : Min. value of specified pressure \leq Lo \leq Max. value of specified pressure

Hi setting range : Lo < Hi \leq Max. value of specified pressure

- OUT 1 : It will be ON between High limit value(Hi) and Low limit value (Lo)
- OUT 2 : It will be ON when it is beyond High limit value(Hi) and Low limit value(Lo).

Function(PSA/PSB)

1. Change of display unit

PS□-V01(C)(P)/PS□-C01(C)(P) has 7 kinds of pressure unit and PS□-01(C)(P)/PS□-1(C)(P) has 4 kinds of pressure unit.

Please select the proper unit for application.

- PS□-V01(C)(P), PS□-C01(C)(P) :
kPa, kgf/cm², bar, psi, mmHg, inHg, mmH₂O
- PS□-01(C)(P), PS□-1(C)(P) :
kPa, kgf/cm², bar, psi

※When using mmH₂O, multiply the display value by 100.

2. Change of output mode

There are 6 kinds of control output modes in order to provide the various detection.

Select a mode for your proper application.

- Hysteresis mode(F-1) :
When variable hysteresis is required for pressure detection.
- Automatic sensitivity setting mode(F-2) :
When it is required to set detecting sensitivity automatically at proper position.
- Independent 2 output mode(F-3, F-4, F-5) :
When it is required to detect pressure from two position with one product.
- Window output mode(F-6) :
When is required to detect pressure in a certain range.

3. Change of response time(Chattering prevention)

It can prevent chattering of control output by changing response time. It is able to set 4 kinds of response time(2.5ms, 5ms, 100ms, 500ms) and if the response is getting longer, the sensing will be more stable by increasing the number of digital filter.

4. Change of Analog output scale

It is not only used to set the analog output(1-5VDC) scale for a rated pressure range, but also can be used to change the range for proper user's application. Setting A1 position for 1VDC output and A2 position for 5VDC output. Therefore, analog output will be 1-5VDC between A1 and A2.

5. Key lock function

This unit has 2 kinds of key lock function in order to prevent wrong operation.

- **Loc** : All keys are locked, it is impossible to change any parameter setting/preset, Zero point adjustment, Peak hold and Bottom hold.
- **PA.L** : This is partial locked status, it is impossible to change parameter setting(Able to change the status of lock) only, the other functions can be changed.
- **UnL** : All keys are unlocked.

6. Zero point adjustment function

This function is to set the display value of pressure at zero when port is opened to atmospheric pressure.

7. Peak hold and Bottom hold function

This function is diagnosis malfunction of the system caused by parasitic pressure or to check through memorizing the max./min. pressure that occurred in the system.

8. Error

Error display	Problem	Solution
Er1	External pressure is applied, when adjusting Zero point	Please try again after external pressure removing
Er2	When it is overloaded on control output	Remove overload
Er3	When the setting value is not matched with setting condition	Set proper setting value after checking setting condition
HHH	When the applied pressure exceeds the upper display pressure range up	Apply pressure within display pressure range
LLL	When the applied pressure exceeds the lower display pressure range down	

Installation(PSA)

- When installing pressure port, it is able to bring pressure from 3 directions by changing the mounting direction of the pressure port.
- Basic spec of pressure port is NPT 1/8(Color:Black). [Option:PT 1/8(Color:Silver)] It is able to use general one touch fitting.
- Please use seal tape at port plug in order to prevent pressure leak.
- Please block another two pressure ports not used with port plug.
- Please connect it by using spanner(13mm) at the metal part in order not to overload on the body when connecting one touch fitting.

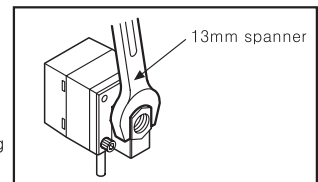
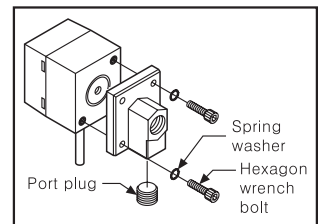
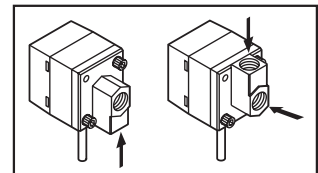

Caution

The tightening torque of one touch fitting should be max. 10N · m. It may cause mechanical trouble.

- PSA series has 2 kinds of brackets so it is able to install it in two different ways.
- At first, please unscrew hexagon wrench bolt and assemble the bracket on this unit by fixing the hexagon wrench bolt.

In this case, tightening torque of hexagon wrench should be max. 3N · m. It may cause mechanical trouble.

- Bracket(PSO-01) and front protection cover(PSO-02) are optional to sell. Please see the pictures for installation.

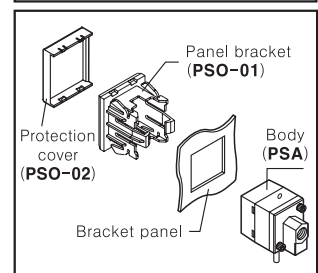
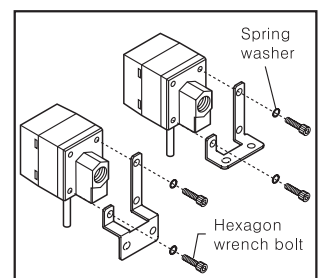

(A) Counter

(B) Timer

(C) Temp. controller

(D) Power controller

(E) Panel meter

(F) Tacho/Speed/Pulse meter

(G) Display unit

(H) Sensor controller

(I) Switching power supply

(J) Proximity sensor

(K) Photo electric sensor

(L) Pressure sensor

(M) Rotary encoder

(N) Stepping motor & Driver & Controller

(O) Graphic panel

(P) Production stoppage models & replacement

PSA / PSB Series

Installation(PSB)

1. Pressure port is M5.
It is able to use general one touch fitting.
2. It is able to use it without the pressure port according to environment. In this case, O-Ring between pressure port and its body should not be taken out in order not to prevent pressure leak.
3. Please connect it by using spanner(10mm) at pressure port in order not to overload on the body when connecting one touch fitting.

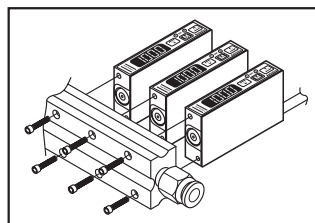
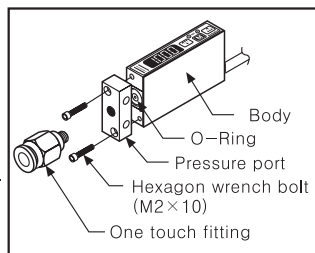

Caution

The tightening torque of one touch fitting and hexagon wrench should be Max. 5N · m and 2N · m. It may cause mechanical problem.

Please do not use spanner to install as it may cause mechanical problem.

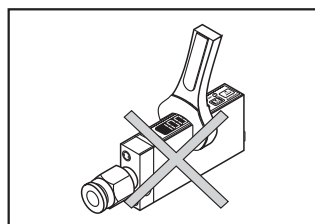
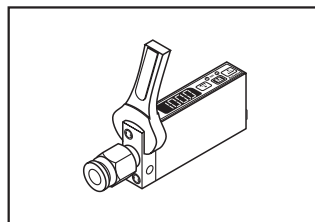

Accessory

PSA/PSB

- Pressure unit label

±100kPa	-101.3kPa	100kPa	1MPa
1.03kgf/cm ²	-1.03kgf/cm ²	1.03kgf/cm ²	10.3kgf/cm ²
14.50psia	-14.70psia	14.50psia	145.0psia
1.000bar	-1.013bar	1.000bar	10.000bar
750mmHg	-760mmHg	X10	X10
29.53inHg	-29.6inHg	X100	X100
1.02.0mmHg	-103.4mmHg	X1000	X1000

DISPLAY UNIT LABEL

PSA

- Port plug
- Bracket A
- Bracket B

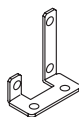
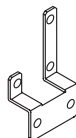

Proper usage

Caution

PSA, PSB Series is for sensing of non corrosive gas. Do not use this product at corrosive gas or flammable gas etc.

- Please using this unit within range of specification, if applying pressure is larger than specification, it may not be working properly due to damage.
- After supplying power, it takes 3 sec. to work.
- When using switching regulator as power supply, it must be grounded(F · G).

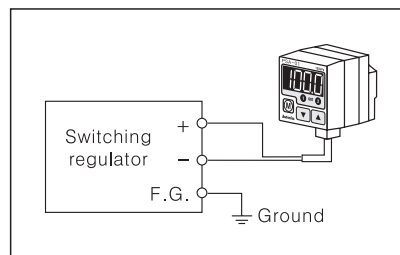

- It may cause malfunction by noise, when wiring with power line or high voltage line.
- Do not insert any sharp or pointed object into pressure port.
It may cause mechanical problem due to sensor damage.
- Do not use this unit with flammable gas, this is not an explosion proof structure.
- Be sure that this unit should not be contacted directly with water, oil, thinner etc.

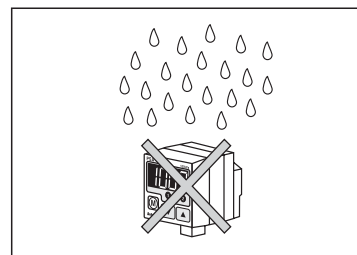

- Wiring must be done with power off.