

Cooling/Defrost Temperature Controller

DIN W72 × H36mm Cooling/Defrost Temperature controller

Features

- ON/OFF Control
- Input specification ☞ Basic specification:NTC(Thermistor), Option:RTD(DIN Pt100Ω)
- Includes delay functions.
Auto/Manual Defrost selection function, Start-up delay of compressor, Re-operation delay, Minimum ON time, Delay of defrost-end, Operation delay of evaporation-fan
- Input correction function
- It is available to set operation period for protecting compressor in error.



⚠ Please read "Caution for your safety" in operation manual before using.



Ordering information

TC 3 Y F - 1 4 R

Item	TC	3	Y	F	-	1	4	R
Digit								
Size								
Control								
Control output								
Power supply								
Output								
								R
								Relay output
								4
								100-240VAC 50/60Hz
								1
								Compressor
								2
								Compressor+Defrost output
								3
								Compressor+Defrost output+Evaporation output
								F
								Freezing(Freezing control)
								Y
								DIN W72×H36mm
								3
								3Digit
								TC
								Temperature Controller

Specifications

Model	(★1) TC3YF-14R	TC3YF-24R	TC3YF-34R
Power supply	100-240VAC 50/60Hz		
Allowable voltage range	90 to 110% of rated voltage		
Power consumption	4VA		
Display method	7 Segment LED Display (Red)		
Indication range	NTC : -40.0 ~ 99.9°C (40 ~ 212°F), RTD : -99.9 ~ 99.9°C (-148 ~ 212°F)		
Display accuracy	[PV ±0.5% or ±1°C Max.] rdg ±1digit		
Sampling period	Min. 0.5sec		
Input sensor	(★2) NTC : Thermistor, RTD : DIN PT 100Ω		
Input of line resistance	Tolerance line resistance is max. 5Ω		
Control method	ON/OFF control (Adjustment sensitivity 0.5~5.0°C, 2~50°F variable)		
Control output	Compressor (250VAC 5A 1a)	Compressor (250VAC 5A 1a) Defrost output (250VAC 10A 1a)	Compressor (250VAC 5A 1a) Defrost output (250VAC 10A 1a) Evaporation-fan output (250VAC 5A 1a)
Memory protection	Approx. 10 years (When using non-volatile semiconductor memory)		
Insulation resistance	Min. 100MΩ (at 500VDC)		
Dielectric strength	2000VAC 60Hz for 1 minute (between all external terminal and case)		
Noise strength	±2kV R-phase and S-phase (pulse width 1μs)		
Relay life cycle	COMP	Mechanical : Min.20,000,000 times, Electrical : Min.50,000 times (250VAC 5A resistive load)	
	DEF	Mechanical : Min.20,000,000 times, Electrical : Min.100,000 times (250VAC 10A resistive load)	
	FAN	Mechanical : Min.20,000,000 times, Electrical : Min.50,000 times (250VAC 5A resistive load)	
Vibration	Mechanical	0.75mm amplitude at frequency of 10 to 55Hz in each of X, Y, Z directions for 2 hours	
	Malfunction	0.5mm amplitude at frequency of 10 to 55Hz in each of X, Y, Z directions for 10 minutes	
Ambient temperature	-10 ~ 50°C (at non-freezing status)		
Storage temperature	-20 ~ 60°C (at non-freezing status)		
Ambient humidity	35 ~ 85%RH		
Unit weight	Approx. 143g		

※(★1) There is no defrost function (★2) RTD(PT 100Ω) type is optional.

(A) Counter

(B) Timer

(C) Temp. controller

(D) Power controller

(E) Panel meter

(F) Tacho/Speed/Pulse meter

(G) Display unit

(H) Sensor controller

(I) Switching power supply

(J) Proximity sensor

(K) Photo electric sensor

(L) Pressure sensor

(M) Rotary encoder

(N) Stepping motor & Driver & Controller

(O) Graphic panel

(P) Production stoppage models & replacement

TC3YF

Connections

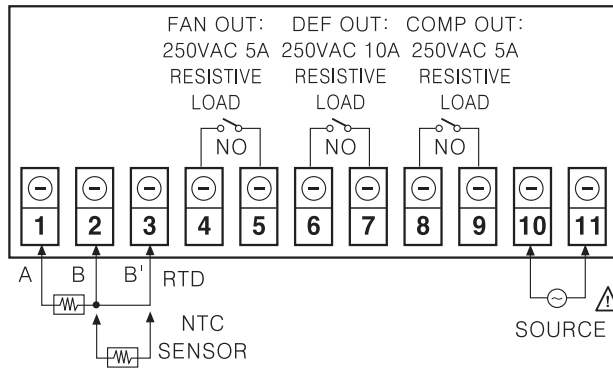

Dimensions

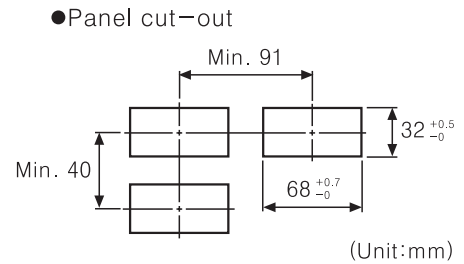
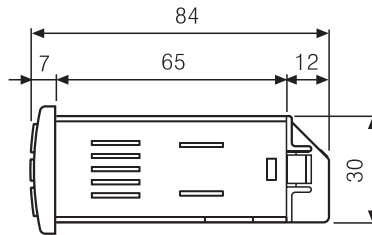
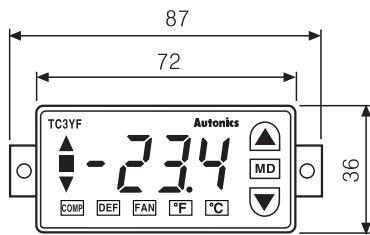

Front panel identification

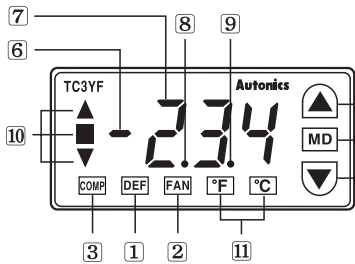

- ① DEF (Defrost output lamp) : Light is ON when defrost output is ON
- ② FAN (Evaporation—fan output lamp) : Light is ON when evaporation output is ON.
- ③ COMP (Compressor output lamp) : Light is ON when compressor output is ON.
- ④ MD (Mode key) : For entering, changing shifting parameters
- ⑤ ▼ ▲ (Setting key: Up/Down) : For changing parameters
- ⑥ - : Displaying minus symbol
- ⑦ Display process value) : Display a current value (SV) on RUN mode.
 Display a parameter and a setting value when setting parameter.
- ⑧ ● (Display a decimal point) : Display a decimal point when the time unit is 'Min'
- ⑨ ● (Display a decimal point) : Display a decimal point when the temperature unit is '°C'
- ⑩ ▲, ■, ▼ (Display a deviation) : "▲" indication turns on when PV is higher than SV, "▼" indication turns on when PV is lower than SV
- ⑪ °C, °F (Temperature unit) : Selectable °C or °F

※When delay time is applied, the output lamp of defrost output, evaporation—fan and compressor is ON simultaneously after the lamp flashes every one second.

How to set and change setting value(5μ)

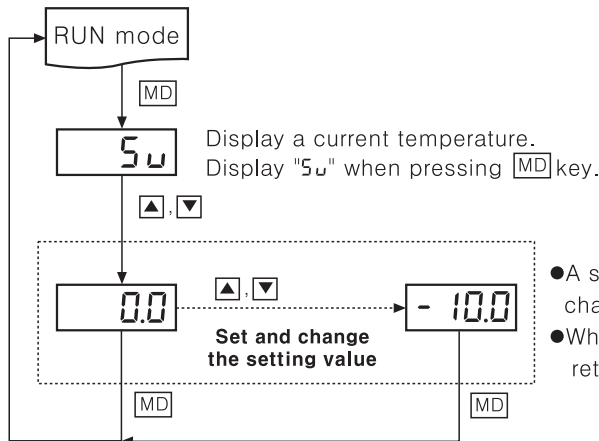

Input specification and range

Input specification	Setting temperature/Using range	
	°C	°F
RTD (DPT 100Ω)	-99.9 ~ 99.9	-148 ~ 212
Thermistor	-40.0 ~ 99.9	-40 ~ 212

※The setting range of temperature is fixed as using range.

- A setting value flashes every 0.5 sec, and it is available to change the value with ▲ or ▼ key.
- When pressing MD key, a setting value is saved and it returns to operation mode.

- ※If any key is untouched for 60sec, it returns to operation mode.
- ※When pressing MD key for displaying setting value, it returns to operation mode.
- ※When ▼ key at "0.0", minus values are available to set.
- ※Pressing ▲ key (▼ key) continuously, a number is increases/decreases fast.

Cooling/Defrost Temperature Controller

Flow chart for setting group 1

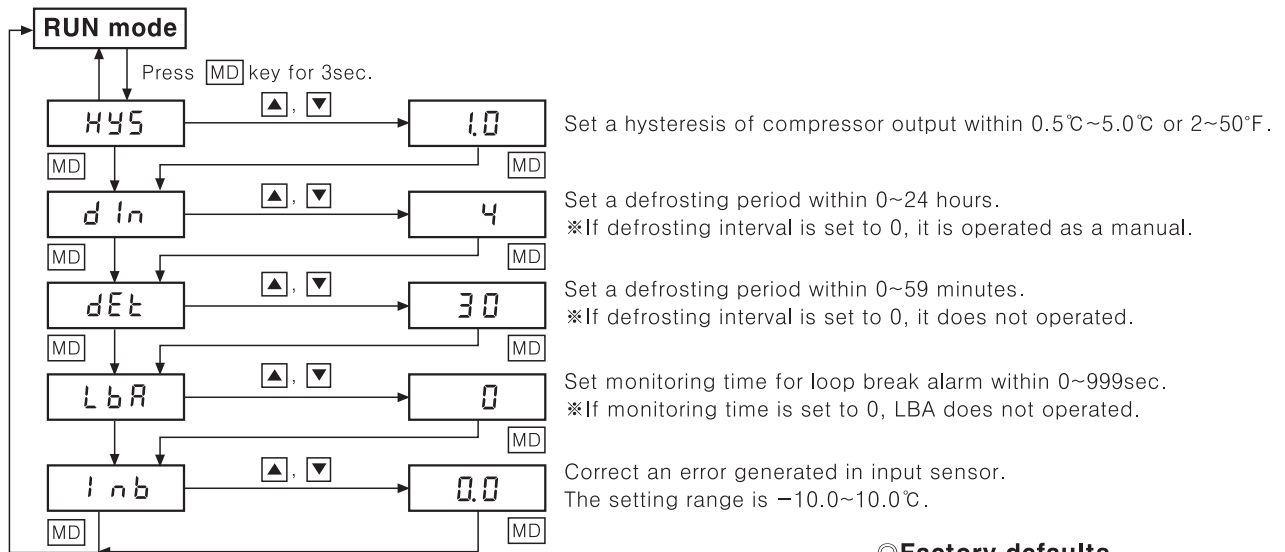

- *In RUN mode, if **MD** key is pressed for 3 sec, it enters into setting group 1 and displays **HYS**.
- ***HYS** parameter is displayed when entering into setting group 1.
- *Press **MD** key during setting operation to save the changed setting value and display next parameter.
- *Press **MD** key for 3 min during setting operation, it returns to RUN mode.

Factory defaults

Mode	Setting value	Mode	Setting value
HYS	1.0	LbA	0
dIn	4	Inb	0.0
dEt	30		

Flow chart for setting group 2

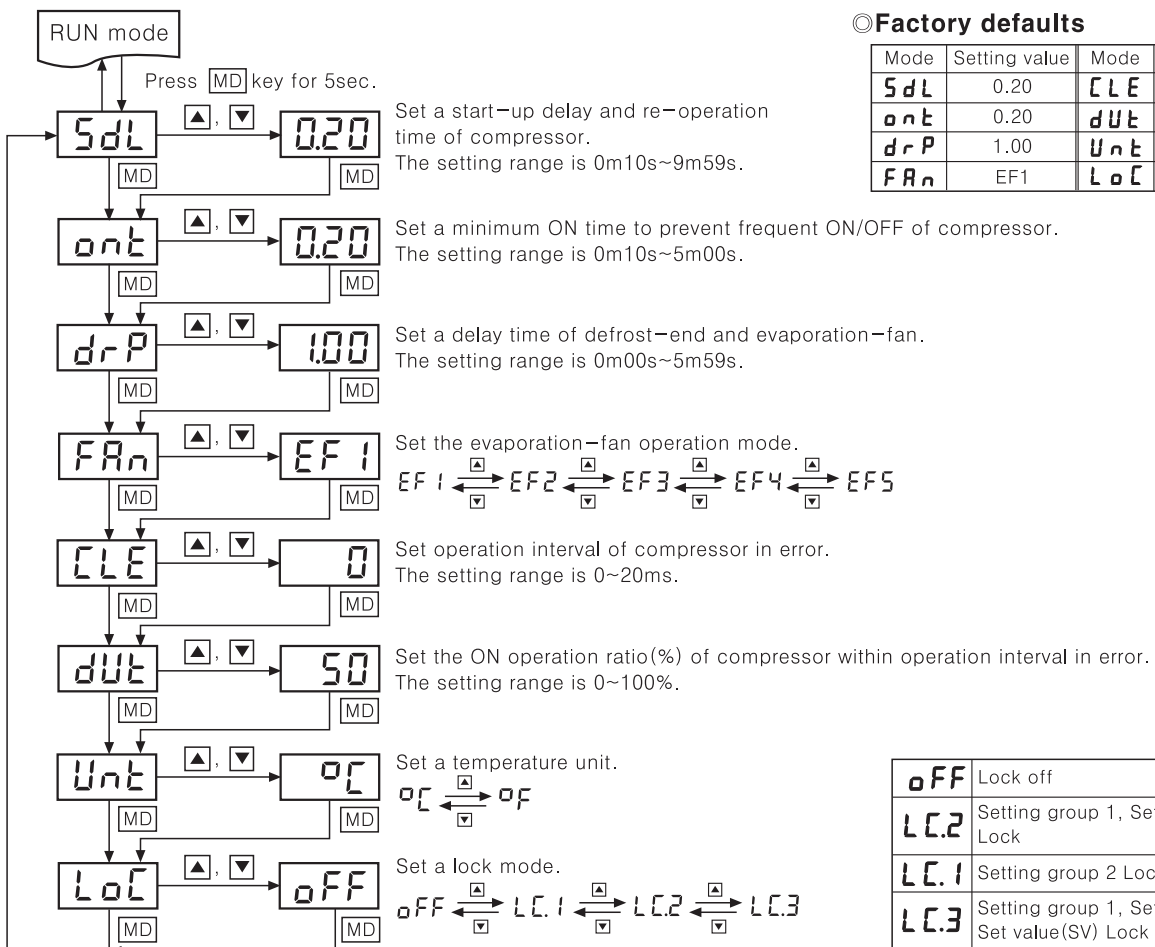

Factory defaults

Mode	Setting value	Mode	Setting value
SdL	0.20	CLt	0
onT	0.20	dUt	50
drP	1.00	UnT	°C
FRn	EF1	LoC	oFF

oFF	Lock off
LC.2	Setting group 1, Setting group 2 Lock
LC.1	Setting group 2 Lock
LC.3	Setting group 1, Setting group 2, Set value(SV) Lock

- *In RUN mode, if **MD** key is pressed for 5 sec, it enters into setting group 2 and displays **SdL**.
- ***SdL** parameter is displayed when entering into setting group 2.
- *Press **MD** key during setting operation to save the changed setting value and display next parameter.
- *Press **MD** key for 3 sec during setting operation, it returns to RUN mode.

(A) Counter

(B) Timer

(C) Temp. controller

(D) Power controller

(E) Panel meter

(F) Tacho/Speed/Pulse meter

(G) Display unit

(H) Sensor controller

(I) Switching power supply

(J) Proximity sensor

(K) Photo electric sensor

(L) Pressure sensor

(M) Rotary encoder

(N) Stepping motor & Driver & Controller

(O) Graphic panel

(P) Production stoppage models & replacement

Function and operation

● Hysteresis [HY5]

- TC3YF operates as ON/OFF control and controls compressor output.
- The compressor can be damaged by frequent ON/OFF cycle at setting value. Therefore it can establish Hysteresis between activation temperature and deactivation temperature to prevent the compressor.
- EX) If TC3YF is established as setting temperature (SV) as -20°C , hysteresis (HY5) as 1.0, the compressor output is ON when it is reached -19°C and it is OFF when it is reached -21°C .
- ※ In ON/OFF control, the temperature is lower than SV, the output is OFF and it is ON when it is higher and it is also designated as dual position control.
- ※ The setting range of hysteresis is $0.5\sim 10.0^{\circ}\text{C}$ ($2\sim 50^{\circ}\text{F}$).

● Input correction [Inb]

- It corrects an error generated by temperature sensor inputted from external.
- Ex) When room temperature is -18°C , the display temperature of temperature controller is -20°C , set the input correction (Inb) value as 2.0, it is corrected as -18°C .
- ※ The setting range of input correction is $-10.0^{\circ}\text{C}\sim 10.0^{\circ}\text{C}$. ($-18\sim 18^{\circ}\text{F}$)

● Defrost

When compressor is operated for a long time, the efficiency is lowered by the frosts evaporator and freezer built in. A defrost designates to remove frost and ice around the evaporator.

● Heating defrost (Auto defrost)

Mount a heater next to an evaporator and operate it with defrost interval [dIn] and time [dEt] of temperature controller, removing frost and ice.

● Manual defrost

When pressing ▲ key is pressed for 3 sec, the defrosting is activated for defrost time [dEt] during the compressor operation.

The prior defrost interval value is not deleted.

※ When pressing ▲ key for 3 sec, it returns to auto defrost. (The defrost interval starts again from defrost output is OFF.)

※ When defrost interval is set to "0.0", it is only operated as manual defrost.

※ When it used as manual defrost, compressor output and evaporation-fan output are OFF when the defrost output is ON.

※ The setting range of defrost interval [dIn] is 0~24 hours and defrost time [dEt] is 0~59 min.

● Freezing (Compressor) operation

Temperature control : Keep the setting temperature by repeating ON/OFF operation in the range of hysteresis.

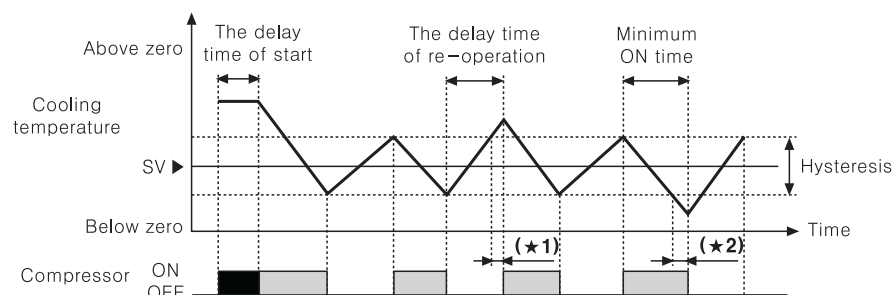

※ ■ : The output is not operated, only the front COMP lamp is flashing.

● The delay time of start-up and re-operation [5dL]

1) Delay of start-up : When applying the power again on a compressor after power is failed, the compressor will be overloaded. In this case, delay of start-up prevents curtailing of the life cycle of a compressor. The setting range is 0m10s~9m59s.

※ The output lamp is ON simultaneously after the lamp flashes every one second during delay time.

2) Delay of re-operation : It does not operate within delay time of re-operation after compressor turned OFF to prevent frequent ON/OFF. The setting range is 0m10s~9m59s.

※ (★1) For delay time of start-up, compressor output is OFF even when PV is lower than SV. It is turned ON after delay time of re-operation is over.

● Minimum ON time [onE]

Set a minimum ON time to prevent frequent ON/OFF. The setting range is 0m10s~5m00s.

※ (★2) Compressor output is ON even when PV is lower than hysteresis. It is turned to OFF after the minimum ON time is over.

Cooling/Defrost Temperature Controller

◎Defrost operation(Heating defrost)

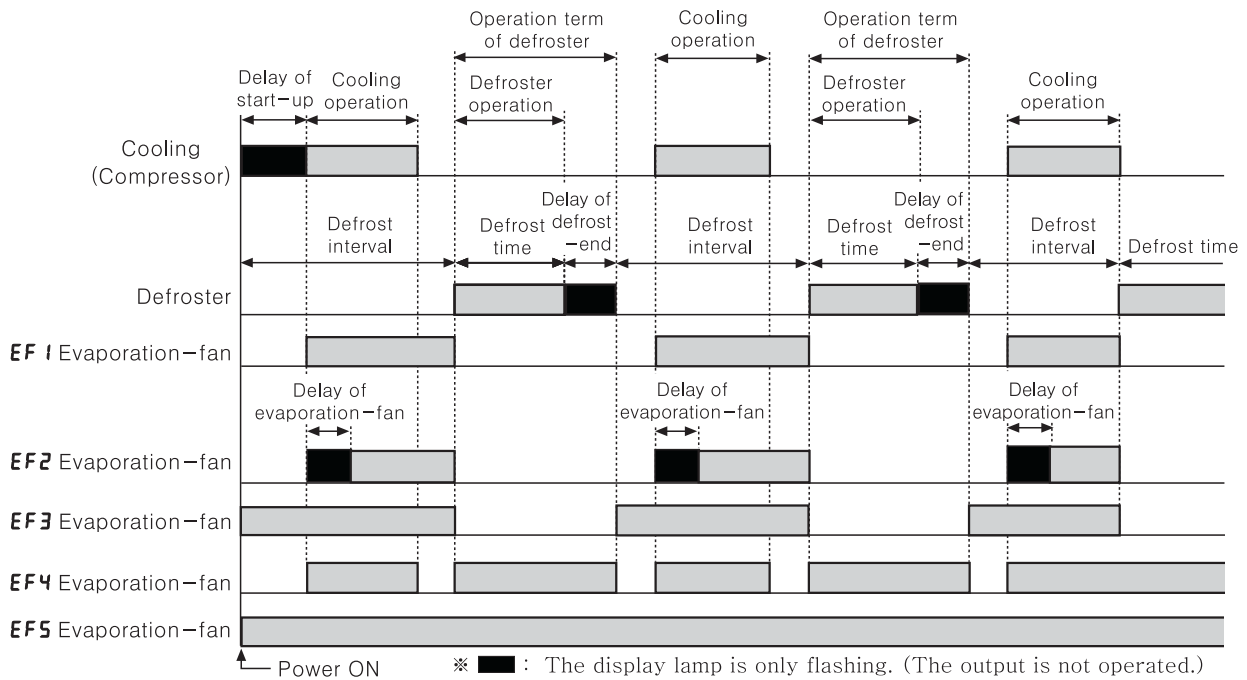

●Defrost interval [dIn]

It starts to defrost for relevant interval. The setting range is 0~24 hours.

When the defrost interval is set to "0.0", it is only operated as manual.

●Defrost time [dEt]

The defroster (heater) is ON during defrost time. The setting range is 0m~59m.

●The delay time of defrost-end / evaporation-fan operation [Dripping Time : $d-rP$]

1)The delay time of defrost-end : It is the time for draining remained drops. After the delay time is over, compressor starts operating. (The setting range : 0m00s~5m59s)

2)The delay time of evaporation-fan operation : To improve the efficiency of cooling system, the operation of evaporation fan is delayed until evaporation plate gets frozen after compressor operating. (The setting range : 0m00s~5m59s)

※The delay time of defrost-end and evaporation-fan operation are applied with one setting time. ($d-rP$)

※When the delay time of defrost-end is finished, defrost is discontinued and defrost interval is repeated.

※The output lamp is ON simultaneously after the lamp flashing every one second during the delay time.

◎Evaporation operation mode [FRn]

●Operation mode 1 [$EF1$] : It operates same as freezer.

●Operation mode 2 [$EF2$] : It operates after the delay time of evaporation-fan operation. OFF during defrost operation.

●Operation mode 3 [$EF3$] : It is started when the power is applied and only operated during the defrost interval. (It does not any influence upon the freezer.)

●Operation mode 4 [$EF4$] : The evaporation-fan operates only in the operation term of freezer or defrost, it is OFF when compressor and defroster are stopped. (It is used to control the above zero temperature.)

●Operation mode 5 [$EF5$] : It is started when the power is applied and it works until the power is failed.

◎Display an error

Err mark and content are flashing every 0.5 sec when error is occurred.

Err / oPn	Input sensor is disconnected
Err / LbA	Input sensor is normal or freezer temperature is not changed over 1.0°C (2°F) for observation time(LbA) of loop break.
Err / LLL	Process temperature (PV) is lower than the display range
Err / HHH	Process temperature (PV) is higher than the display range

※The error display of $oPn/LLL/HHH$ disappears after the abnormal factors are cleared. (Sensor connection/returning to the display range)

(A) Counter

(B) Timer

(C) Temp. controller

(D) Power controller

(E) Panel meter

(F) Tacho/Speed/Pulse meter

(G) Display unit

(H) Sensor controller

(I) Switching power supply

(J) Proximity sensor

(K) Photo electric sensor

(L) Pressure sensor

(M) Rotary encoder

(N) Stepping motor & Driver & Controller

(O) Graphic panel

(P) Production stoppage models & replacement

◎Operation cycle [**CL E**] / ON duty ratio of compressor in error [**dU t**]

When an error occurs, repeats ON/OFF operation based on setting values of operation cycle (**CL E**) and ON duty ratio (**dU t**) of second setting group to protect the inside of the compressor. This is repeated until error is removed.

※ The setting range of operation cycle : 0~20 min,

The setting range of ON duty ratio : 0~100%

※ When operation cycle of compressor is "0", it keeps OFF status in error. The ON duty ratio (**dU t**) is not displayed in error.

※ The duty ratio of compressor ON is "100", it keeps ON status in error.

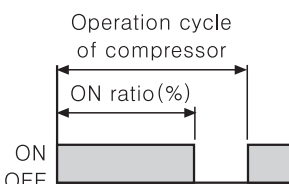

◎Alarming of loop disconnection(LBA : Loop Break Alarm)

When the cooling temperature is not changed over 1.0°C (2°F) during monitoring time set at loop break alarm (**Lb A**) parameter, it is regarded as abnormal operation. It displays **Err** and **Lb A** every 0.5sec and the compressor output repeats ON/OFF by the operation cycle (**CL E**) and ON duty ratio (**dU t**) setting in error.

When pressing **[MD]** key simultaneously for 3sec, after checking the compressor, it operates normally with cancelling the error. LBA function does not operated when LBA value is at "0".

(LBA setting range : 0~999sec)

◎Set the Lock [**L o C**]

Limit the change of SV and parameter.

oFF : Lock off

L C. 1 : Lock the second setting group

L C. 2 : Lock the first and second setting groups

L C. 3 : Lock the first and second setting groups and SV

■Proper usage

1. Please beware not to exceed the rated specification of relay when using relay contact or it may cause a fire with breakdown.
2. Please mount a surge absorption device at coil when controlling high-capacity power relay or a magnet, the counter electromotive force can be flowed into the inside of the device for relay contact operation.
3. Please install a power switch or circuit breaker in order to cut power supply off.
4. The switch or a circuit breaker should be installed near by user for easy operation.
5. Do not use this temperature controller as a Volt-meter or Ampere-meter.
6. In case of using RTD sensor, please connect as 3 wire type and use 3 same thickness of lines when you need to extend. It might cause the deviation of temperature if the resistance of line is different.
7. Please check the polarity and connect correctly when connecting RTD sensor to temperature controller. NTC sensor is a non-polarity.
8. In case of making power line and input signal line close, line filter for noise protection should be installed at power line and input signal line should be shielded.
(Note) Please make sensor line shortly and use it because the narrow range of input correction range.
9. Keep away from the high frequency instruments. (High frequency welding machine & sewing machine, high-capacity SCR controller etc.)
10. Please use AWG No. 12~28 for power input and relay output connection, fasten the terminal block as a torque 0.3Nm.
11. Installation environment
 - ①It shall be used indoor
 - ②Pollution Degree 2
 - ③Altitude Max. 2000m
 - ④Installation Category II